

SAFETY PRECAUTIONS

Please read this operation manual carefully before installation, operation, maintenance or inspection.

The precautions related to safe operation are classified into “WARNING” , and “CAUTION”.



Points out potential danger which, if not avoided, may cause physical injury or death.



Points out potential danger which, if not avoided, may result in mild or moderate physical injury and damage to the equipment. It's also available to warns about unsafe operations.

In some cases, even the content described in “Note” may also cause serious accidents.

So please follow these important precautions in any situations.

★ [NOTE] is the necessary step to ensure the proper operation.

Warning signs are presented on the front cover of inverters. Please follow these instructions when using the inverter.

Warning symbol

WARNING

To avoid personal injury and equipment damage.

Do not apply power or operate this inverter until the instruction manual has been read thoroughly.

Do not touch the conductive part of the inverter while the charge lamp is on. Perform inspection or parts replacement only after this lamp goes out.

Do not connect supply power to output terminals U.V.W.

Use good earthing. Earth the inverter before wiring the power circuits and control circuits.

1. INTRODUCTION

1.1 Technology Features

- Input & Output
 - ◆ Input Voltage Range: 380/220V±15%
 - ◆ Input Frequency Range: 47~63Hz
 - ◆ Output Voltage Range: 0~rated input voltage
 - ◆ Output Frequency Range: 0~400Hz
- I/O Features
 - ◆ Programmable Digital Input: Provide 7 terminals which can support ON-OFF inputs, 1 terminal which can support high speed pulse input and support PNP, NPN
 - ◆ Programmable Analog Input: AI2 can accept input of -10V ~10V · AI2 can accept input of 0~10V or 0~20mA.
 - ◆ Programmable Open Collector Output: Provide 1 output terminal (open collector output or high speed pulse output)
 - ◆ Relay Output: Provide 2 output terminals
 - ◆ Analog Output: Provide 2 output terminal, whose output scope can be 0/4~20 mA or 0~10 V , as chosen.
- Main Control Function
 - ◆ Control Mode: V/F control, Sensorless Vector Control (SVC), Torque control
 - ◆ Overload Capacity: 60s with 150% of rated current, 10s with 180% of rated current.
 - ◆ Speed Adjusting Range: 1:100 (SVC)
 - ◆ Carrier Frequency: 1 kHz ~15.0 kHz.
 - ◆ Frequency reference source: keypad, analog input, HDI, serial communication, multi-stage speed, simple PLC and PID setting. The combination of multi-modes and the switch between different modes can be realized.
 - ◆ PID Control Function
 - ◆ Simple PLC, Multi-Steps Speed Control Function: 16 stages speed can be set.
 - ◆ Traverse Control Function
 - ◆ None-Stop when instantaneous power off.
 - ◆ Speed Trace Function: Smoothly start the running motor.
 - ◆ [QUICK/JOG] Key: User defined shortcut key can be realized.
 - ◆ Automatic Voltage Regulation Function (AVR):

- ◆ Automatically keep the output voltage stable when input voltage fluctuating
- ◆ Fault protections: Protect from over current, over voltage, under voltage, over temperature, phase failure, over load etc

1.2 Description of Nameplat

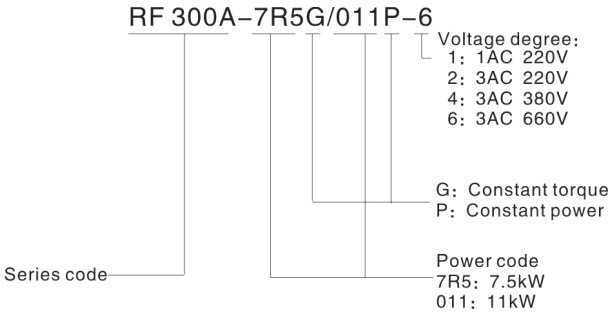

2. UNPACKING INSPECTION



CAUTION

Don't install or use any inverter that is damaged or has fault parts, otherwise physical injury

may occur

Check the following items after unpacking the inverter and inverter motor,

1. Inspect the entire exterior of the inverter and inverter motor to ensure there are no scratches or other damage caused by the transportation.
2. Ensure there is operation manual in the packing box.
3. Inspect the nameplate and ensure it is what you ordered.
4. Ensure the optional parts are what you need if you have ordered ones.

Please contact the local agent if there is any damage to the inverter and inverter motor or optional parts.

3. DISASSEMBLE AND INSTALLATION



- Only qualified people are allowed to operate on the drive device/system. Ignoring the instructions in “warning” may cause serious physical injury or death or property loss.
- Connect the input power lines tightly and permanently. And ground the device with proper techniques.
- Even when the inverter is stopped, dangerous voltage is present at the terminals:
 - Power Terminals: R, S, T
 - Motor Connection Terminals: U, V · W.
- Stop the drive and disconnect it from the power line. Wait for 10 minutes to let the drive discharge and then begin the installation.
- Minimum cross-sectional areas of the grounding conductor should be at least 10mm^2 , Or you can select the larger one between the cross-sectional area of the power cord conductors and the cross-sectional area of the grounding conductor according to the following table:

the cross-sectional areas of power cord conductors mm^2	the cross-sectional areas of grounding conductors mm^2
$S \leq 16$	S
$16 < S \leq 35$	16
$35 < S$	S/2



- Lift the inverter by its base other than the keypad or the cover. The dropping of the main part may cause physical injury.
- The inverter is fixed on a non-flammable wall such as metal and away from heat and flammable materials to avoid the fire.
- If more than two drives are installed in a cabinet, the temperature should be lower than 40°C by means of a cooling fan. Overheat may cause fire or damage to the drive.

3.1 Environmental Requirement

3.1.1 Temperature and Humidity

The ambient temperature is among $-10\text{ }^{\circ}\text{C}$ ~ $40\text{ }^{\circ}\text{C}$ and the inverter has to derate by 4% for every additional $1\text{ }^{\circ}\text{C}$ if the ambient temperature exceeds $40\text{ }^{\circ}\text{C}$. The temperature cap is $50\text{ }^{\circ}\text{C}$.

Relative humidity of the air $\leq 90\%$. No condensation is allowed.

3.1.2 Altitude

The inverter can run at the rated power if the installation site is less than 1000m(including 1000m) above the sea level. But it has to derate if the altitude exceeds 1000m. See the following figure for details:

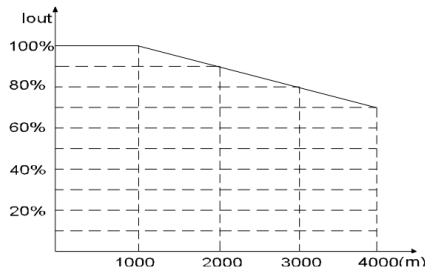

Figure 3.1 Relationship between output current and altitude

3.1.3 Other environment requirements

The inverter can not bear fierce impact or shock. So the oscillation range should be less than $5.8\text{m/s}^2(0.6\text{g})$.

The inverter should keep away from the electromagnetic radiation source.

The inverter should keep away from water and condensation.

The inverter should keep away from contaminative air, such as corrosive gas, oil mist and conductive dust.

The inverter should keep away from direct sunlight, oil mist, steam and vibration environment.

4. WIRING



- Only qualified electricians are allowed to operate on the safe running of the inverter.
- Never carry out any insulation or voltage withstand tests on the cables connecting with the inverter.
- Even if the inverter is stopped, dangerous voltage is present at the input power lines, DC circuit terminals and motor terminals. Wait for 10 minutes even when the inverter is switched off until its discharge the CHARGE light is off before operation.
- Ground the grounding terminals of the inverter with proper techniques. And the resistor should be less than 10Ω . Otherwise there is danger of electrical shock and fire.
- Do not connect 3-phase power supply to the output terminals (U, V, W) of the inverter, otherwise damage to the inverter may occur.
- Please ensure the right connection between the power supply wires and motor wires. Connect the power supply to the R, S and T terminals and connect motor wires to U, V and W terminals.
- Never do wiring or other operations on the servo drive with wet hands. Otherwise there is danger of electric shock.



- Verify that the rated voltage of the inverter equals to the voltage of the AC power supply.
- The power wires and motor wires must be permanently fastened and connected.

4.1 Connection of Peripheral Devices

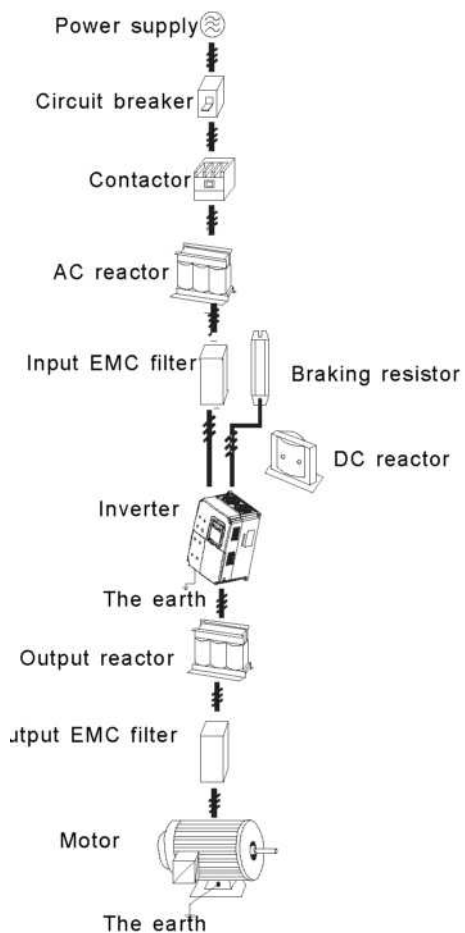

Figure 4.1 Connection of peripheral devices.

4.2 Terminal Configuration

4.2.1 Main Circuit Terminals (380VAC)



Figure 4.2 Main circuit terminals (0.75 ~ 2.2kW)

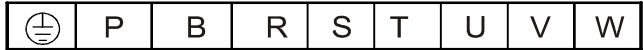

Figure4-3 Main circuit terminals(4~7.5kW)

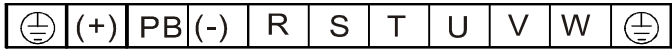

Figure4-4 Main circuit terminals(11~18.5kW)

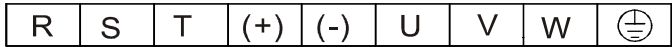

Figure4-5 Main circuit terminals(22~30kW)

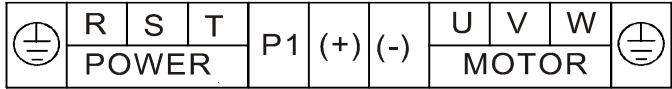

Figure4-6 Main circuit terminals(37~110kW)

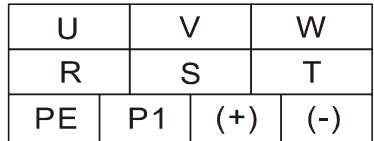
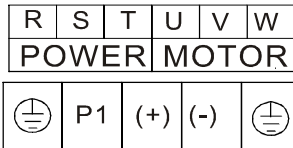

Figure4-7 Main circuit terminals(132~315kW) Figure4-8 Main circuit terminals(350~500kW)

4.2.2 Main Circuit Terminals(220VAC) :



Figure4-9 Main circuit terminals(0.75~1.5kW)

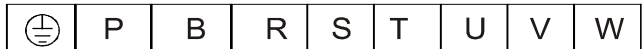

Figure4-10 Main circuit terminals(2.2~5.5kW)

4.2.3 Main Circuit Terminals(660VAC)

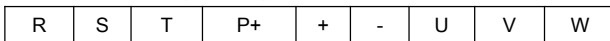



Figure4-11 Main circuit terminals(18.5-110kW)

The function of main circuit terminals are described as follows:

Terminal Symbol	Function Description
R、 S、 T	Terminals of 3 phase AC input
(⁺)(-)	Spare terminals of external braking unit
(+) PB	Spare terminals of external braking resistor
P1 (+)	Spare terminals of external DC reactor
(-)	Terminal of negative DC bus
U、 V、 W	Terminals of 3 phase AC output
	Terminal of ground
(+)	Terminal of positive DC bus

4.2.4 Control Circuit Terminals

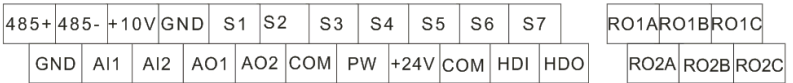

Figure 4.12 Control circuit terminals.

4.3 Wiring Diagram

4.3.1 Typical Wiring Diagram

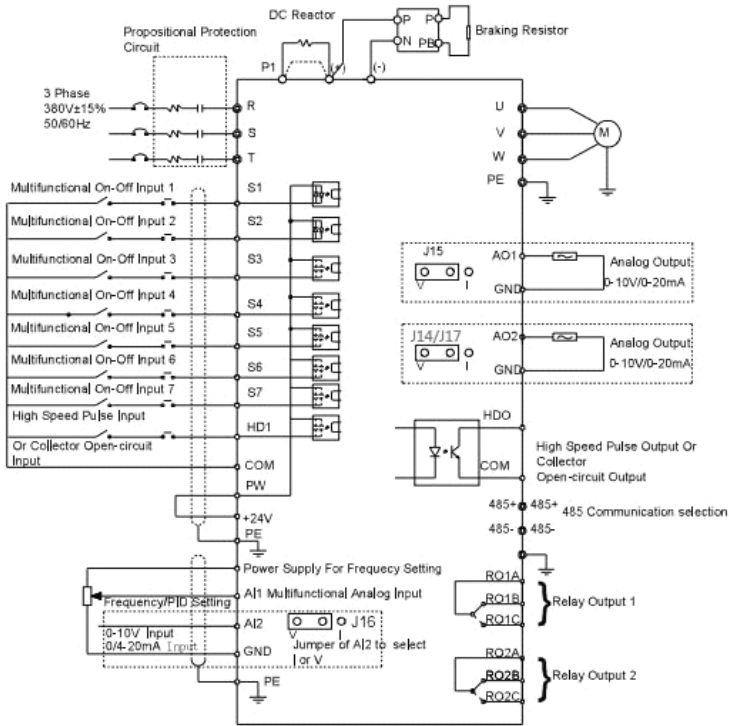

Figure 4.13 Typical Wiring diagram

4.3.2 Output and input signal connection

Set the common emitter/common collector mode and internal/external power supply by U-shaped contact tag. The factory setting is the common emitter.

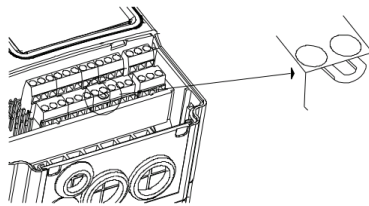

Figure 4.14 U-shaped contact tag

Common emitter mode:

Please set the U-shaped contact tag according to the applied power supply, if the input signal is from the NPN transistor.

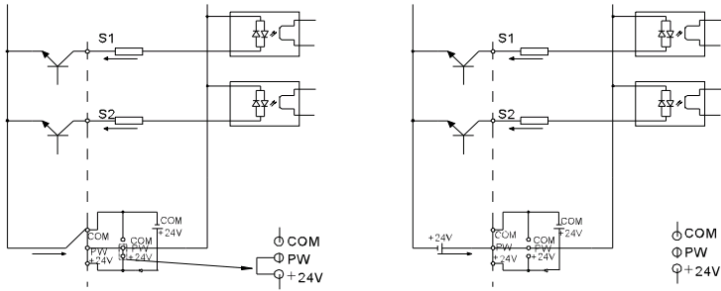

Figure 4.15 Common emitter modes

Please set the U-shaped contact tag according to the applied power supply, if the input signal is from the PNP transistor.

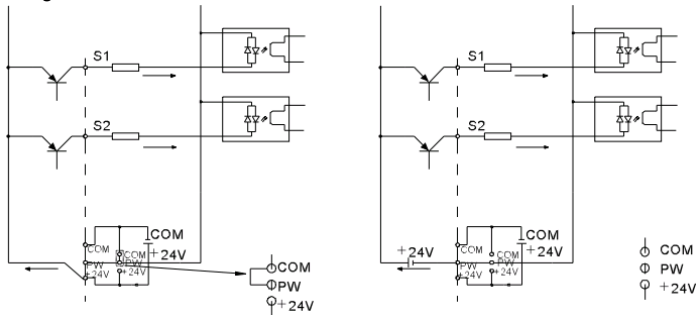

Figure 4.16 Common collector modes

4.4 Wiring Main Circuits

4.4.1 Wiring at input side of main circuit

4.4.1.1 Circuit breaker

It is necessary to connect a circuit breaker which is compatible with the capacity of inverter between 3ph AC power supply and power input terminals (R, S, and T). The capacity of breaker is 1.5~2 times to the rated current of inverter. See *Specifications of Breaker, Cable, and Contactor* for the detail that the capacity of the inverter should between 1.5~2 times of the rated current of the inverter.

4.4.1.2 Electromagnetic contactor

In order to cut off the input power effectively when fault occurs to the system, it is necessary to install a contactor at the input side to control the ON-OFF of the main circuit power supply.

4.4.1.3 Input AC reactor

In order to prevent the rectifier damage result from the large current when peak pulse input, AC reactor should be installed at the input side. It can also be used to improve the power factor of the input side. For the effective protection, it is recommended to install input reactor for inverters of 380V/110kW (including 110kW) and install input reactor for inverters of 220V/45kW.

4.4.1.4 Input EMC filter

The surrounding device may be disturbed by the cables when the inverter is working. EMC filter can minimize the interference. Just like the following figure.

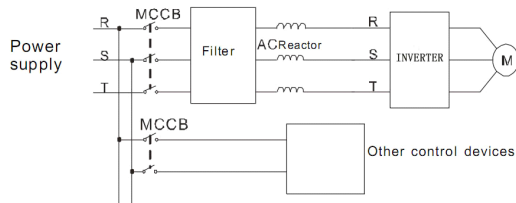

Figure4.17 Main circuit wiring at input side

4.4.2 Wiring at inverter side of main circuit

4.4.2.1 DC reactor

The series inverters from 18.5kW to 90kW (380V) are equipped with internal DC reactors for the improvement of power factors and the avoidance of damage from high input current to the rectifying components because of the high-capacity transformer. The inverter can also cease the damage to the rectifying components which are caused by supply net voltage transients and harmonic waves of the loads.

4.4.2.2 Braking unit and braking resistor

- The series inverters below 5kW (380V) are equipped with internal braking unit. In order to dissipate the regenerative energy generated by dynamic braking, the braking resistor should be installed at (+) and PB terminals.
- The wire length of the braking resistor should be less than 5m.
- Please pay attention to safety prevention and smooth ventilation when installing braking resistors because the temperature will rise for the heat releasing.

■ The (+) and (-) terminal of the braking units corresponds to the (+) and (-) terminal of the inverter when the external braking unit is connected. Connect braking resistor to the BR1 and BR2 terminal of the braking unit.

■ The wiring length between the (+) , (-) terminals of the inverter and the (+) , (-) terminals of the braking units should be no more than 5m, and the distributing length among BR1 and BR2 and the braking resistor terminals should be no more than 10m.

Note: Be sure that the electric polarity of (+) (-) terminals is right; it is not allowed to connect (+) with (-) terminals directly, otherwise damage or fire may occur.

4.4.3 Wiring at motor side of main circuit

4.4.3.1 Output Reactor

Output reactor must be installed in the following condition. When the distance between inverter and motor is more than 50m, inverter may be tripped by over-current protection frequently because of the large leakage current resulted from the parasitic capacitance with ground. And the same time the output reactor should be installed to avoid the damage of motor insulation,

4.4.3.2 Output EMC filter

EMC filter should be installed to minimize the leakage current caused by the cable and minimize the radio noise caused by the cables between the inverter and cable. Just see the following figure.

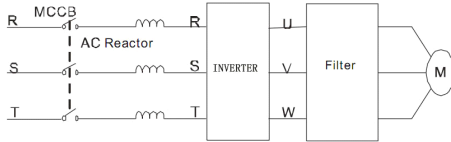

Figure 4.18 Wiring at motor side

4.4.4 Wiring of regenerative unit

Regenerative unit is used for putting the electricity generated by braking of motor to the grid. Compared with traditional 3 phase inverse parallel bridge type rectifier unit, regenerative unit uses IGBT so that the total harmonic distortion (THD) is less than 4%. Regenerative unit is widely used for centrifugal and hoisting equipment. See *The Instruction of RBU Series Energy Feedback Unit* for detailed information.

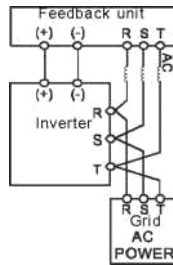

Figure 4.19 Wiring of regenerative unit.

4.4.5 Wiring of Common DC bus

Common DC bus method is widely used in the paper industry and chemical fiber industry which need multi-motor to coordinate. In these applications, some motors are in driving state while some others are in regenerative braking (generating electricity) state. The regenerated energy is automatically balanced through the common DC bus, which means it can supply to motors in driving state. Therefore the power consumption of whole system will be less compared with the traditional method (one inverter drives one motor).

When two motors are running at the same time (i.e. winding application), one is in driving state and the other is in regenerative state. In this case the DC buses of these two inverters can be connected in parallel so that the regenerated energy can be supplied to motors in driving status whenever it needs.

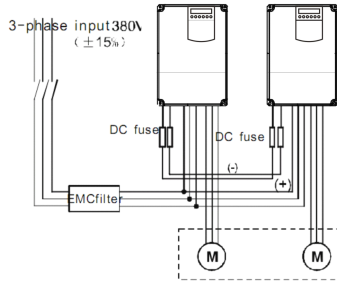

Figure 4.20 Wiring of common DC bus.

Note: Two inverters must be the same model when connected with Common DC bus method. Be sure they are powered on at the same time.

4.4.6 Ground Wiring (PE)

In order to ensure safety and prevent electrical shock and fire, terminal PE must be grounded with ground with proper techniques and the grounding resistor is less than 10Ω . The grounding wire should be short with a thick diameter, and it is better to use multi-wires which have copper core ($>3.5\text{mm}^2$). When multiple inverters need to be grounded, it is recommended to use command grounding wire for the avoidance of loop the ground wire.

4.5 Wiring Control Circuit

4.5.1 Precautions

Use shielded or twisted-pair cables to connect control terminals.

Connect the ground terminal (PE) with shield wire.

The cable connected to the control terminal should be left away from the main circuit and strong current circuits (including power supply cable, motor cable, relay and contactor connecting cable) at least 20cm and parallel wiring should be avoided. It is suggested to apply perpendicular wiring to prevent inverter malfunction caused by external interference.

4.5.2 Control circuit terminals

Terminal	Description
S1-S7	ON-OFF signal input, optical coupling with PW and COM. Input voltage range: 9~30V Input impedance: 3.3k Ω
HDI	High speed pulse or ON-OFF signal input, optical coupling with PW and COM. Pulse input frequency range: 0 ~ 50kHz Input voltage range: 9~30V Input impedance: 1.1 k Ω
PW	External power supply. +24V terminal is connected to PW terminal as default setting. If the external power supply is needed · disconnect +24V terminal with PW terminal and connect PW terminal with external power supply.
+24V	Local power supply of +24V(current: 150mA)
COM	The common terminal of +24V
AI1	Analog input; -10V ~ 10V Input impedance: 20k Ω
AI2	Analog input, 0~10V/ 0~20mA , switched by J16. Input impedance: 10k Ω (voltage input) / 250 Ω (current input)

Terminal	Description
GND	Common ground terminal of analog signal and +10V. GND must be isolated from COM.
+10V	+10V for the inverter.
HDO	High speed pulse or open collector output terminal. The corresponding common terminal is COM. Output frequency range: 0~50 kHz

AOI and AO2	Above 4kW: analog output terminals, of which AOI can be selected to voltage output or current output by J15; AO2 can be selected to voltage output or current output by J17. Output range : voltage(0~10V) /current (0~20mA)
	1.5 ~2.2kW: analog output terminals, of which AOI can be selected to voltage output or current output by J15; AO2 can be selected to voltage output or current output by J14. Output range : voltage(0~10V) /current (0~20mA)
RO1A, RO1B and RO1C	RO1 relay output: RO1A~common; RO1B—NC; RO1C—NO. Contact capacity: AC 250V/3A, DC 30V/1A.
RO2A, RO2B and RO2C	RO2 relay output: RO2A—common; RO2B—NC; RO2C—NO. Contact capacity: AC 250V/3A, DC 30V/1A.
485+ and 485-	485 communication port. 485 differential signal, + , -. Please use twisted pairs and shielded cables on the standard communication port.

4.5.3 Jumper on control board

Jumper	Description
J1	Switch of AI1 input; PANELconnect to AI1 means keypad POT input; PORTconnect to AI1 means terminal voltage input;
J2 · J4	It is prohibited to be connected together, otherwise it will cause inverter malfunction.
J16	Switch between (0~10V) voltage input and (0~20mA) current input. V connect to GND means voltage input; I connect to GND means current input.
J15and J17 (above 4.0kW)	Switch between (0~10V) voltage output and (0~20mA) current output.
Jumper	Description
J14and J15 (0.75~2.2kW)	If V is short circuited with GND, it is voltage output; If I is short circuited with GND, it is current output.
SW1	Switch of terminal resistor for RS485 communication. Dail to ON means connecting to terminal resistor, while dail to OFF means disconnecting to terminal resistor. (Only valid for inverter of 4.0kW or above)
J7	RS485 communication jumper
J17, J18	Switch of terminal resistor for RS485 communication. Jumper enable: Connect terminal resistor. Jumper disable: Disconnect terminal resistor. (Only valid for inverter of 0.75~2.2kW).

4.6 Installation Guidline to EMC Compliance

4.6.1 General knowledge of EMC

EMC is the abbreviation of electromagnetic compatibility, which means the device or system has the ability to work normally in the electromagnetic environment and will not generate any electromagnetic interference to other equipments.

EMC includes two aspects: electromagnetic interference and electromagnetic immunity. According to the transmission mode, Electromagnetic interference can be divided into two categories: conducted interference and radiated interference.

Conducted interference is the interference transmitted by conductor. Therefore, any conductors (such as wire, transmission line, inductor, capacitor and so on) are the transmission channels of the interference.

Radiated interference is the interference transmitted in electromagnetic wave, and the energy is inverse proportional to the square of distance.

Three necessary conditions or essentials of electromagnetic interference are: interference source, transmission channel and sensitive receiver. Controlling these factors is right the point of settling the EMC issue. For customers, the solution of EMC problem is mainly originated from transmission channel because of transimitting source and receiver are not changable.

4.6.2 EMC features of inverter

Like other electric or electronic devices, inverter is not only an electromagnetic interference source but also an electromagnetic receiver. The operating principle of inverter determines that it can generate certain electromagnetic interference noise. At the same time inverter should be designed with certain anti-jamming ability to ensure the smooth working in certain electromagnetic environment. Following is its EMC features:

4.6.2.1 Input current is non-sine wave. The input current includes large amount of high-harmonic waves that can cause electromagnetic interference, decrease the grid power factor and increase the line loss.

4.6.2.2 Output voltage is high frequency PMW wave, which can increase the temperature rise and shorten the life of motor. And the leakage current will also

4.6.2.3 increase, which can lead to the leakage protection device malfunction and generate strong electromagnetic interference to influence the reliability of other electric devices.

4.6.2.4 As an electromagnetic receiver, too strong external interference will cause malfunction and damage. The inverter can not work normally.

4.6.2.5 In the system, EMS and EMI of inverter coexist. Decrease the EMI of inverter can increase its EMS ability.

4.6.3 EMC Installation Guideline

In order to ensure all electric devices in the same system to work smoothly, this section, based on EMC features of inverter, introduces EMC installation process in several aspects of application (noise control, site wiring, grounding, leakage current and power supply filter). The good effective of EMC will depend on the good effective of all of these five aspects.

4.6.3.1 Noise control

All the connections to the control terminals must use shielded wire. And the shield layer of the wire must ground near the wire entrance of inverter. The ground mode is 360 degree annular connection formed by cable clips. It is strictly prohibitive to connect the twisted shielding layer to the ground of inverter, which greatly decreases or loses the shielding effect.

Connect inverter and motor with the shielded wire or the separated cable tray. One side of shield layer of shielded wire or metal cover of separated cable tray should connect to ground, and the other side should connect to the motor cover. Installing an EMC filter can reduce the electromagnetic noise greatly.

4.6.3.2 Site wiring

Power supply wiring: the power should be separated supplied from electrical transformer. Normally it is 5 core wires, three of which are fire wires, one of which is the neutral wire, and one of which is the ground wire. It is strictly prohibitive to use the same line to be both the neutral wire and the ground wire

Device categorization: there are different electric devices contained in one control cabinet, such as inverter, filter, PLC and instrument etc, which have different ability of emitting and withstanding electromagnetic noise. Therefore, it needs to categorize these devices into strong noise device and noise sensitive device. The same kinds of device should be placed in the same area, and the distance between devices of different category should be more than 20cm.

Wire Arrangement inside the control cabinet: there are signal wire (light current) and power cable (strong current) in one cabinet. For the inverter, the power

cables are categorized into input cable and output cable. Signal wires can be easily disturbed by power cables to make the equipment malfunction. Therefore when wiring, signal cables and power cables should be arranged in different area. It is strictly prohibitive to arrange them in parallel or interlacement at a close distance (less than 20cm) or tie them together. If the signal wires have to cross the power cables, they should be arranged in 90 angles. Power input and output cables should not either be arranged in interlacement or tied together, especially when installed the EMC filter. Otherwise the distributed capacitances of its input and output power cable can be coupling each other to make the EMC filter out of function.

4.6.3.3 Grounding

Inverter must be ground safely when in operation. Grounding enjoys priority in all EMC methods because it does not only ensure the safety of equipment and persons, but also is the simplest, most effective and lowest cost solution for EMC problems.

Grounding has three categories: special pole grounding, common pole grounding and series-wound grounding. Different control system should use special pole grounding, and different devices in the same control system should use common pole grounding, and different devices connected by same power cable should use series-wound grounding.

4.6.3.4 Leakage Current

Leakage current includes line-to-line leakage current and over-ground leakage current. Its value depends on distributed capacitances and carrier frequency of inverter. The over-ground leakage current, which is the current passing through the common ground wire, can not only flow into inverter system but also other devices. It also can make leakage current circuit breaker, relay or other devices malfunction. The value of line-to-line leakage current, which means the leakage current passing through distributed capacitors of input output wire, depends on the carrier frequency of inverter, the length and section areas of motor cables. The higher carrier frequency of inverter, the longer of the motor cable and/or the bigger cable section area, the larger leakage current will occur.

Countermeasure:

Decreasing the carrier frequency can effectively decrease the leakage current. In the case of motor cable is relatively long (longer than 50m), it is necessary to install AC reactor or sinusoidal wave filter at the output side, and when it is even longer, it is necessary to install one reactor at every certain distance.

4.6.3.5 EMC Filter

EMC filter has a great effect of electromagnetic decoupling, so it is preferred for customer to install it.

For inverter, noise filter has following categories:

- Noise filter installed at the input side of inverter;
- Install noise isolation for other equipment by means of isolation transformer or power filter.

4.6.4 The installation complies with following standards:

- EN61000-6-4: Electromagnetic Interference Detection on the industrial condition.
- EN61800-3: Comply with the electromagnetic radiation standard of EN61800-3 (The second environment). Can comply with the electromagnetic radiation standard of EN61000-6-3(residence) and standard of EN61000-6-4.
- This type of PDS is not intended to be used on a low-voltage public network which supplies domestic premise;
- Radio frequency interference is expected if used on such a network.

5. OPERATION

5.1 Keypad Description

5.1.1 Keypad schematic diagram

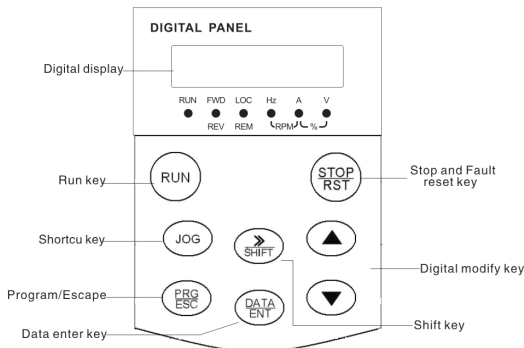







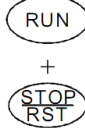

Figure 5.1 Keypad schematic diagram

5.1.2 Function key description

Key	Name	Function Description
	Program/Escape	Enter or escape from the first level menu,
	Data enter Key	Progressively enter menu and confirm parameters.
	Digital modify key	Progressively increase data or function codes.
	Digital modify key	Progressive decrease data or function codes.
	Shift Key	In parameter setting mode, press this button to select the bit to be modified. In other modes, cyclically displays parameters by right shift
	Run Key	Start to run the inverter in keypad control mode.
	Stop/Reset Key	In running status, restricted by P7.04, can be used to stop the inverter. When fault alarm , can be used to reset the inverter without any restriction.

Key	Name	Function Description
	Shortcut Key	Determined by Function Code P7.03: 0 : splay status switching 1 : jog operation 2 : Switch between forward and reverse 3 : Clear the UP/DOWN terminals settings. 4 : Quick debugging mode
	Combination Key	Pressing the [RUN] and [STOP/RST] at the same time can achieve inverter coast to stop.

5.1.3 Indicator light description

5.1.3.1 Function Indicator Light Description

Function indicator	Description
[RUN/TUNE]	Extinguished: stop status Flickering: parameter autotuning status Light on: operating status
[FWD/REV]	Extinguished: forward operation Light on: reverse operation.
[LOCAL/REMOT]	Extinguished: keypad control Flickering: terminal control Light on: communication control
[TRIP]	Extinguished: normal operation status Flickering: overload pre-warning status Light on: fault of the inverter

5.1.3.2 Unit Indicator Light Description

Unit indicator	Description
Hz	Frequency unit
A	Current unit
V	Voltage unit
RPM	Rotating speed unit
%	Percentage

5.1.3.3 Digital Display

Have 5 digit LED , which can display all kinds of monitoring data and alarm codes such as reference frequency, output frequency and so on.

5.2 Operation Process

5.2.1 Parameter setting

Three levels of menu are:

- Function code group (first-level);
- Function code (second-level);
- Function code value (third-level).

Remarks:

Press either the [PRG/ESC] or the [PATA/ENT] can return to the second- level

menu from the third- level menu. The difference is: pressing [DATA/ENT] will save the set parameters into the control panel, and then return to the second-level menu with shifting to the next function code automatically; while pressing [PRG/ESC] will directly return to the second-class menu without saving the parameters, and keep staying at the current function code.

Example: modify the function code P1.01 from 00.00Hz to 01.05Hz.

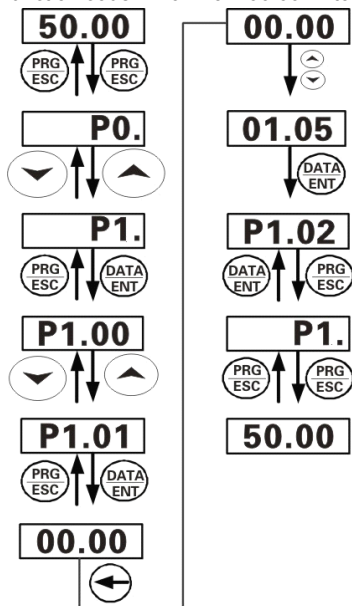

Figure 5.2 Flow chart of parameter setting.

Under the third- level menu, if the parameter has no flickering bit, it means the function code cannot be modified. The possible reasons could be:

- This function code is not modifiable parameter, such as actual detected parameter, operation records and so on;
- This function code is not modifiable in running status, but modifiable in stop status.

5.2.2 Fault reset

If fault occurs to the inverter, it will inform the related fault information. User can use [STOP/RST] or according terminals determined by P5 Group to reset the fault. After fault reset, the inverter is in stand-by state. If user does not reset the inverter when it is in fault state, the inverter will be in operation protection state,

and can not run.

5.2.3 Motor parameters autotuning

Input right nameplate parameter of the motor before the running of the inverter. The series inverter matches the standard motor parameter according to the nameplate. The series inverter support parameter autotune to improve the control performance.

The procedure of motor parameter autotuning is as follows:

Firstly, choose the keypad command channel as the operation command channel (P0.01).

And then input following parameters according to the actual motor parameters:

- P2.01: motor rated power;
- P2.02: motor rated frequency;
- P2.03: motor rated speed;
- P2.04: motor rated voltage;
- P2.05: motor rated current;

Set P0.16 to be 1 , and for the detail process of motor parameter autotuning, please refer to the description of Function Code P0.16. And then press [RUN] on the keypad panel, the inverter will automatically calculate following parameter of the motor. See the instruction of P0.16 for the detailed information.

- P2.06: motor stator resistance;
- P2.07: motor rotor resistance;
- P2.08: motor stator and rotor inductance;
- P2.09: motor stator and rotor mutual inductance;
- P2.10: motor current without load;

Then motor autotuning is finished.

The keypad will display TUN-1 and TUN-2 during autotune. When the keypad displays -END-, the parameter autotune has been finished.

Note: The motor should be de-coupled from the load; otherwise, the motor parameters obtained by autotuning may be incorrect.

5.2.4 Password setting

The series inverter provides password protection function to users. Set P7.00 to gain the password and the password protection becomes effective instantly after quitting form the function code editing state. Press [PRG/ESC] again to the function code editing state, “----” will be displayed. Unless using the correct password, the operators cannot enter it.

Set P7.00 to 0 to cancel password protection function and the password cannot protect the parameters in the quick menu.

5.2.5 Shortcut menu setting

Shortcut menu, in which parameters in common use can be programmed, provides a quick way to view and modify function parameters. In the shortcut menu, a parameter being displayed as “hP.11”, means the function parameter P0.11. Modifying parameters in the shortcut menu has the same effect as doing at normal programming status.

5.3 Running State

5.3.1 Power-on initialization

Firstly the system initializes during the inverter power-on, and LED displays “8.8.8.8.8.”. After the initialization is completed, the inverter is in stand-by status

5.3.2 Stand-by

In stop or running status, multi-status parameters can be displayed. And these function can be choose to display through function code P7.06 and P7.07 (running parameters) and P7.08(stop parameters) at the binary bits. See the description of P7.06, P7.07 and P7.08 for detailed definition.

In stop status, there are ten stopping parameters which can be chosen to display or not. They are: reference frequency, DC bus voltage, ON-OFF input status, open collector output status, PID setting, PID feedback, analog input AH voltage, analog input AI2 voltage, HDI frequency, step number of simple PLC and multi-step speed. Whether or not to display depends on setting the corresponding binary bit of P7.08. Press the [] /SHIFT to scroll through the parameters in right order. Press[DATA/ENT] +[QUICK/JOG] to scroll through the parameters in left order.

5.3.3 Operation

In running status, there are twenty-two running parameters which can be chosen to display or not. They are: running frequency, reference frequency, DC bus voltage, output voltage, output current, rotating speed, line speed, output power, output torque, PID setting, PID feedback, ON-OFF input status, open collector output status, length value, count value, step number of PLC and multi-step speed, voltage of AM, voltage of AI2, high speed pulse input HDI frequency. Whether or not to display depends on setting the corresponding bit of P7.06, P7.07. Press the [] /SHIFT to scroll through the parameters in right order. Press [DATA/ENT] +[QUICK/JOG] to scroll through the parameters in left order.

5.3.4 Fault

In fault status, inverter will display parameters of STOP status besides parameters of fault status. Press the [] /SHIFT to scroll through the parameters in right order. Press [DATA/ENT] +[QUICK/JOG] to scroll through the

parameters in left order.

The series inverter offers a variety of fault information. For details, see inverter faults and their troubleshooting.

5.4 Shortcut Menu

Shortcut menu provides a quick way to view and modify function parameters.

Setting the P7.03 to 4, the press [QUICK/JOG], the inverter will search the parameter which is different from the factory setting, save these parameters to be ready for checking. The buffer length of shortcut menu is 32. So when the record data beyonds to 32, can not display the overlength part. Press [QUICK/JOG] will be the shortcut debugging mode. If the [QUICK/JOG] displays "NULLP", it means the parameters are the same with the factory setting. If want to return to last display, press [QUICK/JOG].

6. DETAILED FUNCTION DESCRIPTION

PO Group Basic Function

Function Code	Name	Setting Range
P0.00	Speed Control model	0-2 【0】

This parameter is used to select the speed control mode of the inverter.

0: V/F control: It is only suitable for motor commissioning cases where needs not high accuracy or the cases where one inverter drives multiple motors.

1: Sensorless vector control: It is only suitable for motor commissioning cases or the cases where needs not high accuracy. This mode is applied in the universal high performance cases where the pulse encoder is not installed or the cases where requires high torque at low speed, high speed accuracy, and quicker dynamic response, such as machine tool, injection molding machine, centrifugal machine and wire-drawing machine, etc. One inverter only drives one motor.

2. Torque control (sensorless vector control): It is suitable for the application with low accuracy torque control, such as wired-drawing.

Note:

Set right nameplate parameters of the motor and when selecting vector control mode and complete the parameters autotune before running to get the right motor parameters. Only proper motor parameter can improve the high performance of vector control.

Adjust P3 group can optimize the performance of vector control.

Function Code	Name	Setting Range
P0.01	Run command source	0-2 【0】

The control commands of inverter include: start, stop, forward run, reverse run, jog, and fault reset and so on.

0: Keypad (LED extinguished);

Both [RUN] and [STOP/RST] key are used for running command control. If Multifunction key [QUICK/JOG] is set as [FWD/REV] switching function (P7.03 is set to 2), it will be used to change the rotating orientation.

In running status, pressing [RUN] and [STOP/RST] in the same time will cause the inverter coast to stop.

1: Terminal (LED flickering)



The operation, including forward run, reverse run , forward jog , reverse jog

etc. can be controlled by multifunctional input terminals.

2: Communication (LED lights on)



The operation of inverter can be controlled by host through communication.



Function Code	Name	Setting Range
P0.02	Keypad and terminal UP/DOWN setting	0-3 【0】

The frequency can be set by “”, “” and terminal UP/DOWN. This setting method have the highest and it can be combined with setting channel. It is used to adjust the output frequency during the comissioning of controlling system.

0: valid, and the value can be saved when the inverter is powered off. The frequency command can be set and the value can be saved after the inverter is powered off and it will combinate with the current frequency when it is re powered on.

1: valid, and the value can not be saved when the inverter is powered off. The frequency command can be set but the value can not be saved after the inverter is powered off

2: invalid, the function of “”, “” and terminal UP/DOWN is invalid, and the setting will be cleared automatically.

3: valid during running. The function of “”, “” and terminal UP/DOWN is valid during running and the setting will be cleared automatically when the inverter stops.

Note : When the factory setting is restored, the value of keypad and UP/DOWN will be cleared.

Function Code	Name	Setting Range
P0.03	Maximum frequency	10.00~400.00 【50.00Hz】

This parameter is used to set the Max. Output frequency of the inverter. It is the basic of frequency setting and the speed of ACC/DEC. Please apy attention to it.

Function Code	Name	Setting Range
P0.04	Upper frequency limit	P0.05~P0.03

This is the upper limit of the output frequency and it will be less than or equal to the Max. Output frequency. _____

Function Code	Name	Setting Range
P0.05	Lower frequency limit	0.00-P0.04 【0.00Hz】

This is the lower limit of the output frequency of the inverter.

This parameter can be selected by function code P1.12. If the setting frequency is lower than the upper limit, the inverter will run, stop or hibernate at the lower limit frequency. The Max. Output frequency \geq Upper limit of the frequency \geq Lower limit of the frequency.

Function Code	Name	Setting Range
P0.06	Keypad reference frequency	0.00-P0.03 【50.00Hz】

When Frequency A command source is set to be Keypad, this parameter is the initial value of inverter reference frequency.

Function Code	Name	Setting Range
P0.07	Frequency A command source	0-7 【0】

Select Frequency A command input channel and there are 8 main given frequency channels.

0: Keypad: Please refer to description of P0.06

Set the frequency by the keypad through modifying P0.06.

1:AI1

2:AI2

Set the frequency through analog input terminals. The series inverters provide 2 ways analog input terminal in its standard configuration, of which AI1 is -10V~10V voltage input : AI2 is 0~10V/0(4)~20mA input. The current/voltage can be shifted by J16.

Note: when AI2 selects 0~20mA input, 20mA corresponds to 5V.

100.0% of analog input corresponds to the Max. Frequency (function code P0.03), -100.0% corresponds to the Max. Frequency in reverse (function code P0.03).

3: HDI

The reference frequency is set by high speed pulse input. The series inverters provide 1 way HDI input in its standard configuration.

Pulse specification: pulse voltage range 15~30V, and pulse frequency range 0.0~50.0 kHz. 100% of the setting in pulse corresponds to maximal frequency, while -100% corresponds with minus maximal frequency.

Note: pulse can only be input through multi-function terminal HDI. And set P5.00=0 to select the function of HDI as "setting input".

4. Simple PLC

The inverter will run at simple PLC when selecting this frequency setting method. It is necessary to set the parameter of PA group to determine the given frequency, running direction and each ACC/DEC time. Please refer to the instruction of PA group carefully.

5. Multi-stage speed

The inverter will run at multi-stage speed when selecting this frequency setting method.

The reference frequency is determined by P5 and PA group. If P0.07 is not multi-stage speed setting, then the multi-stage setting has the priority which is lower than the priority of jogging. Only stage 1 ~15 can be set when multi-stage setting has the priority. So stage 1 ~15 can be set when P0.07 is multi-stage speed setting.

6. PID control

The running mode is procedure PID control when selecting this parameter. It is necessary to set P9 group. The reference frequency is the result of PID adjustment. For details, please refer to description of P9 group.

7. Remote Communication

The frequency command is given by the upper monitor through communication given. Please refer to MODBUS communication protocol in chapter 9.

The reference frequency is set through RS485. For details, please refer to Modbus protocol in Chapter 9.

Function Code	Name	Setting Range
P0.08	Frequency B command source	0-2 【0】

- 0 : AI1
- 1 : AI2
- 2 : HDI

When B frequency command is the only frequency reference channel, its application is the same with A frequency command. For details, please refer to P0.07.

Function Code	Name	Setting Range
P0.09	Scale of frequency B command	0~1 【0】

0 : Maximum output frequency, 100% of B frequency setting corresponds to the maximum output frequency

1 : A frequency command, 100% of B frequency setting corresponds to the maximum output frequency. Select this setting if it needs to adjust on the base of A frequency command

Note: If set AI2 to be 0~20mA input, the relative voltage of 20mA is 5V. P0.09 is used when the frequency B is superimposed.

Function Code	Name	Setting Range
P0.10	Frequency command selection	0-3 【0】

0: Only frequency command source A is active.

1: Only frequency command source B is active.

2: Both Frequency command source A and B are active.

Reference frequency = reference frequency A + reference frequency B.

3: Both Frequency command source A and B are active.

Reference frequency = Max (reference frequency A, reference frequency B). Note: Combination (0 , 1 and 2) can be switched by P5 group.

Function Code	Name	Setting Range
P0.11	Acceleration time 0	0.1 ~3600.0s 【Depend on model】
P0.12	Deceleration time 0	0.1 ~3600.0s 【Depend on model】

Acceleration time is the time of accelerating from 0Hz to maximum frequency (P0.03). Deceleration time is the time of decelerating from maximum frequency (P0.03) to 0Hz. Please refer to following figure.

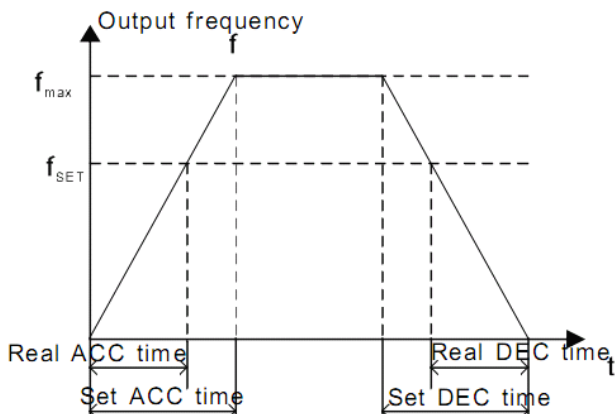

Figure 6.1 Acceleration and deceleration time

When the reference frequency is equal to the maximum frequency, the actual acceleration and deceleration time will be equal to actual setting.

When the reference frequency is less than the maximum frequency, the actual acceleration and deceleration time will be less than actual setting.

The actual acceleration (deceleration) time = setting ACC/DEC time* reference frequency/ maximum frequency.

1st group:P 0.11,P0.12

2nd group:P8.00,P8.01

3rd group:P8.01,P8.03

4th group:P8.04,P8.05

The acceleration and deceleration time can be selected by combination of multifunctional ON-OFF input terminals.

Function Code	Name	Setting Range
P0.13	Running direction selection	0-3 【0】

0: Runs at the default direction, the inverter runs in the forward direction.

1: Runs at the opposing direction, the inverter runs in the reverse direction. This effect equals to the shifting the rotation direction by adjusting either two of the motor wires. Note: If the parameters are restored, the running direction will be back to its original status.

2: Forbid to run in reverse direction: It can be used in some special cases if the reverse running is disabled.

Function Code	Name	Setting Range
P0.14	Carrier frequency	1.0-15.0kHz 【Depend on model】



Carrier frequency	Electromagnetic	Noise Leakage current	Radiating
1kHz			
10kHz			
15kHz			

Figure 6.2 Effect of carrier frequency.

The following table is the relationship between power rating and carrier frequency.

Carrier F Mode	Highest Carrier F (kHz)	Lowest Carrier F (kHz)	Factory setting (kHz)
0.75kW~11kW	15	1.0	8
15kW~55kW	8	1.0	4
75~500kW	6	1.0	2

The advantage of high carrier frequency: ideal current waveform, little current harmonic wave and motor noise.

The disadvantage of high carrier frequency: increasing the switch loss, increasing inverter temperature and the impact to the output capacity. The inverter needs to derate on high carrier frequency. At the same time, the leakage and electrical magnetic interference will increase.

Applying low carrier frequency is contrary to the above, too low carrier frequency will

cause unstable running, torque decreasing and surge.

The manufacturer has set a reasonable carrier frequency when the inverter is in factory. In general, users do not need to change the parameter.

When the frequency used exceeds the default carrier frequency, the inverter needs to derate 20% for each additional 1k carrier frequency.

Function Code	Name	Setting Range
P0.15	AVR function	0-2 【1】

AVR function is the output voltage automatic adjustment function. When AVR is invalid, the output voltage will change with the input voltage (or DC bus voltage); when AVR is valid, the output voltage won't change with the input voltage (or DC bus voltage). The range of output voltage will keep constant. If the site requirement is not met, AVR function can be canceled to shorten the DEC time.

Function Code	Name	Setting Range
P0.16	Motor parameters autotuning	0-2 【0】

0: No action: Forbidding autotuning.

1: Rotation autotuning:

Input right parameters of the motor nameplate (P2.01-P2.05) and do not connect any load to the motor before performing autotuning and ensure the motor is in static and empty status. Otherwise the parameters detected by autotuning will be incorrect.

Set the proper acceleration and deceleration time (P0.11 and P0.12) according to the motor inertia before performing autotuning. Otherwise it may cause over-current and over-voltage fault during autotuning.

Set P0.16 to be 1 then press the [DATA/ENT], LED will display “-TUN-” and flickers. During “-TUN-” is flickering, press the [PRG/ESC] to exit autotuning. Press [RUN] to start the autotuning, and the LED will display “TUN-0” and “TUN-1” “RUN/TUNE” light will flicker. After a few minutes , LED will display “-END-”. That means the autotuning is finished and return to the stop status. When “-TUN-” flickers, pressing [PRG/ESC] can escape from the parameter autotune. During the autotuning, press the [STOP/RST] will stop the autotune.

Note: Only keypad can control the autotuning. P0.16 will restore to 0 automatically when the autotuning is finished.

2: Static autotuning:

- ◆ If it is difficult to disconnect the load, static autotuning is recommended.
- ◆ The series high performance universal inverter Detailed function

description

- ◆ The operation process is the same as rotation autotuning.
But the mutual inductance and the non-load current can not be measured.

Note: The Mutual inductance and current without load will not be detected by static autotuning, if needed user should input suitable value according to experience.

Function Code	Name	Setting Range
P0.17	Restore parameters	0-2 【0】

0: No action

1: Inverter restores all parameters to factory setting.

2: Inverter clear all fault records.

This function code will restore to 0 automatically when complete the function operation.

P1 Group Start and Stop Control

Function Code	Name	Setting Range
P1.00	Start Mode	0-2 【0】

0: Start directly: Start the motor at the starting frequency directly.

1: DC braking and start: Inverter will output DC current firstly and then start the motor at the starting frequency. Please refer to description of P1.03 and P1.04. It is suitable for the motor which have small inertia load and may reverse rotation when start.

2: Speed tracking and start: Inverter detects the rotation speed and direction of motor, then start running to its reference frequency based on current speed. This can realize smooth start of rotating motor with big inertia load when instantaneous power off.

Note: It only applies on the inverter of 7.5kW and above.

Function Code	Name	Setting Range
P1.01	Starting frequency	0.00-10.00Hz 【1.50Hz】
P1.02	Hold time of starting frequency	0.0~50.0s 【0.0s】

Set proper starting frequency can increase the starting torque. The inverter runs from the starting frequency and after the keeping time of the starting frequency, the inverter will accelerate to the aimed frequency during the ACC time. If the reference frequency is less than starting frequency, the inverter will be at stand-by status. The indicator of RUN/TUNE lights on, inverter has no output. The starting frequency could be less than the lower frequency limits. The starting frequency takes no effect during FWD/REV switching.

Function Code	Name	Setting Range
P1.03	DC Braking current before start	0.0-150.0% 【0.0%】
P1.04	DC Braking time before start	0.0~50.0s 【0.0s】

During the DC braking before P1.03, the increased current is the percentage to the rated current of the inverter.

DC braking is invalid when P1.04 is set to be 0.

The bigger the DC braking current, the greater the braking torques.

Function Code	Name	Setting Range
P1.05	Acceleration/ Deceleration mode	0~1 【0】

The frequency changing method during the running and starting of the inverter.

0: Linear Output frequency will increase or decrease with fixed acceleration or deceleration time.

1: Reserved

Function Code	Name	Setting Range
P1.06	Stop mode	0~1 【0】

0: Deceleration to stop

When the stop command takes effect, the inverter decreases the output frequency according to P1.05 and the defined deceleration time till stop.

1: Coast to stop

When the stop command takes effect, the inverter blocks the output immediately.

The motor coasts to stop by its mechanical inertia.

Function Code	Name	Setting Range
P1.07	Starting frequency of DC braking	0.00-P0.03 【0.00Hz】
P1.08	Waiting time before DC braking	0.0~50.0s 【0.0s】
P1.09	DC braking current	0.0-150.0% 【0.0%】
P1.10	DC braking time	0.0~50.0s 【0.0s】

Starting frequency of DC braking: Start the DC braking when running frequency reaches starting frequency determined. Starting frequency of DC braking is 0

and the DC braking is invalid. The inverter will stop in the defined DEC time.

Waiting time before DC braking: Inverter blocks the output before starting the DC braking. After this waiting time, the DC braking will be started so as to prevent over-current fault caused by DC braking at high speed.

DC braking current: The value is the percentage of rated current of inverter. The bigger DC braking current is, the greater the braking torque is.

DC braking time: The time used to perform DC braking. If the time is 0, the DC braking be invalid.

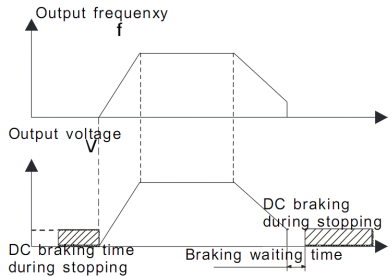

Figure 6.3 DC braking diagram.

Function Code	Name	Setting Range
P1.11	Dead time of FWD/REV	0.0~3600.0s 【0.0s】

Set the hold time at zero frequency in the transition between forward and reverse

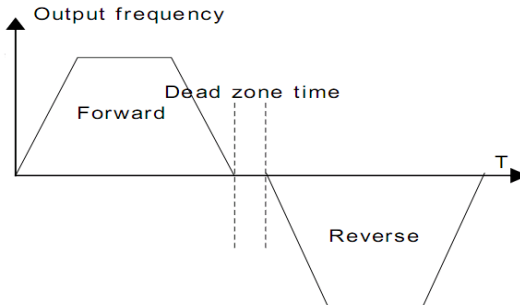

Figure 6.4 FWD/REV dead time diagram.

Function Code	Name	Setting Range

P1.12	Action when running frequency is less than lower frequency limit	0-2 【0】
-------	--	---------

This function code is used to define the running state when the setting frequency is lower than the lower frequency limit.

0: Running at the lower frequency limit: The inverter runs at a frequency which is lower than the lower frequency limit

1: Stop: This parameter is used to prevent motor running at low speed for a long time.

2: Stand-by: Inverter will Coast to stop when the running frequency is less than the lower frequency limit. When the reference frequency is higher than or equal to the lower frequency limit again, the inverter will start to run automatically.

Note: the function is only valid when the lower frequency limit is above 0.

Function Code	Name	Setting Range
P1.13	Delay time for restart	0.0~3600.0s 【0.0s】
P1.14	Restart after power off	0~1 【0】

0: Disabled: Inverter will not automatically restart when power on again until run command takes effect.

1: Enabled: When inverter is running, after power off and power on again, if run command source is key control (P0.01=0) or communication control (P0.01=2), inverter will automatically restart after delay time determined by P1.14; if run command source is terminal control (P0.01=1), inverter will automatically restart after delay time determined by P1.14 only if FWD or REV is active.

Note:

_ If P1.14 is set to be 1, it is recommended that start mode should be set as speed tracing mode (P1.00=2).

• This function may cause the inverter restart automatically, please be cautious.

Function Code	Name	Setting Range
P1.15	Voting time of restart	0.0~3600.0s 【0.0s】

Note: Valid when P1.14=1

Function Code	Name	Setting Range
P1.16	Terminal function examined when power is on	0~1 【0】

This function only takes effect if run command source is terminal control.

If P1.15 is set to be 0 , when power on, inverter will not start even if FWD/REV terminal is active, until FWD/REV terminal disabled and enabled again.

If P1.15 is set to be 1 , when power on and FWD/REV terminal is active, inverter will start automatically.

Note: This function may cause the inverter restart automatically, please use it with cautious.

Function Code	Name	Setting Range
P1.17~P1.19	Reserved	

P2 Group Motor Parameters

Function Code	Name	Setting Range
P2.00	Inverter model	0~1 【Depend on model】

0: G model, Applicable to constant torque load.

1: P model, Applicable to constant power load.

The series inverters apply the manner of G/P unification, which means the power of the motor used in G type is lower than the power of the motor used in P type for one gear.

The factory setting of the inverter is G model. If P model is selected, it is necessary to set the function code to 1 and reset the motor parameters of P2.

For example, the factory setting of RF-4T022G/030P is 22kW G. If it is necessary to change it to 30kW P , set P2.00 to 1 and reset the motor parameters of P2.

Function Code	Name	Setting Range
P2.01	Motor rated power	0.4~3000.0kW 【Depend on model】
P2.02	Motor rated frequency	0.01 Hz~P0.03 【50.00Hz】
P2.03	Motor rated speed	0~36000rpm 【1460rpm】
P2.04	Motor rated voltage	0~800V 【Depend on model】
P2.05	Motor rated current	0.8-6000.0A 【Depend on model】

Note: In order to achieve superior performance, please set these parameters according to motor nameplate, and then perform autotuning.

The inverter provides parameters autotune. Correct parameters autotune is from the right setting of parameter of motor.

The power rating of inverter should match the motor. If the bias is too big, the control performances of inverter will be deteriorated distinctly.

Reset P2.01 can initialize P2.06-P2.10 automatically.

Function Code	Name	Setting Range
P2.06	Motor stator resistance	0.001-65.5350 【Depend on model】
P2.07	Motor rotor resistance	0.001-65.5350 【Depend on model】
P2.08	Motor leakage inductance	0.1~6553.5mH 【Depend on model】
P2.09	Motor mutual inductance	0.1 ~ 6553.5m 【Depend on model】
P2.10	Current without load	0.1-6553.5A 【Depend on model】

After autotuning, the value of P2.06 — P2.10 will be automatically updated. These parameters are the basic parameters for high performance V/F control which have direct impact to the control performance.

Note: Do not change these parameters; otherwise it may deteriorate the control performance of inverter.

P3 Group Vector Control

Function Code	Name	Setting Range
P3.00	ASR proportional gain Kp1	0-100 【20】
P3.01	ASR integral time Kd	0.01 ~ 10.00s 【0.05】
P3.02	ASR switching point 1	0.00-P3.05 【5.00Hz】
P3.03	ASR proportional gain Kp2	0-100 【25】
P3.04	ASR integral time Ki2	0.01-10.00 【1.00s】
P3.05	ASR switching point 2	P3.02~P0.03 【10.00Hz】

The above parameters are only valid for vector control and torque control and invalid for V/F control. Through P3.00~P3.05, user can set the proportional gain Kp and integral time Ki of speed regulator (ASR) , so as to change the speed response characteristic.

P3.00 and P3.01 only take effect when output frequency is less than P3.02. P3.03 and P3.04 only take effect when output frequency is greater than P3.05. When output frequency is between P3.02 and P3.05, K_p and K_i are proportional to the bias between

P3.05. For details, please refer to following figure.

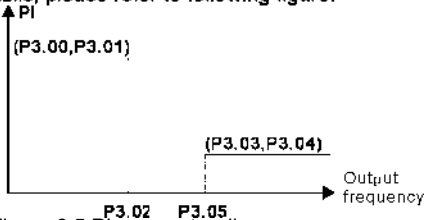

Figure 6.5 PI parameter diagram.

The system's dynamic response can be faster if the proportion gain K_p is increased; However, if K_p is too large, the system tends to oscillate.

The system dynamic response can be faster if the integral time K_i is decreased; However, if K_i is too small, the system becomes overshoot and tends to oscillate.

P3.00 and P3.01 are corresponding to K_p and K_i at low frequency, while P3.03 and P3.04 are corresponding to K_p and K_i at high frequency. Please adjust these parameters according to actual situation. The adjustment procedure is as follow:

- ◆ Increase the proportional gain (K_p) as far as possible without creating oscillation.
- ◆ Reduce the integral time (K_i) as far as possible without creating oscillation.

For more details about fine adjustment, please refer to description of P9 group.

Function Code	Name	Setting Range
P3.06	Slip compensation rate of VC	50% ~200% 【100%】

The parameter is used to adjust the slip frequency of vector control and improve the precision of speed control. Properly adjust this parameter can effectively restrain the static speed bias.

Function Code	Name	Setting Range
P3.07	Torque upper limit	0.0-200.0% 【Depend on model】

Note:

- 100% setting corresponding to rated current. G model : 150.0% : P model:

- 120.0%.
- Under torque control, P3.07 and P3.09 are all related with torque setting.

Function Code	Name	Setting Range
P3.08	Torque setting source	0-5 【0】

0: Keypad (P3.09)

1:AI1

2:AI2

3: HDI

4:Multi-step speed

5:Communication

1 ~5: Torque control is valid, which defines the torque setting source. When the torque setting is minus, the motor will reverse.

Under speed control mode, output torque matches load torque automatically, but limited by P3.07. If the load is above the set upper limit of the torque, the output torque of the inverter will be limited, and the rotation speed of the motor will change automatically. Under the torque control mode, the inverter will output torque at the set command, but the output frequency is limited by the upper or lower limit. When the set torque is above the load torque, the output frequency of the inverter will raise to the upper limit frequency; if the set torque is below the load torque, the output frequency of the inverter will decrease to the lower limit frequency. If the output frequency of the inverter is limited, the output torque will be different from the set torque.

Note:

- Speed control and torque control can be switched by using multi-function input terminals.
- 1~5: 100% corresponding to twice of rated current of inverter.
- When inverter decelerate to stop, Torque control model is switched to speed control mode automatically

Function Code	Name	Setting Range
P3.09	Keypad torque setting	-200.0-200.0% 【50.0%】
P3.10	Upper frequency setting source	0-5 【0】

0: Keypad (P3.09)

1:AI1

2:AI2

3:HDI

4:Multi-step speed

5:Communication

Note: 1~4 100% Corresponds to maximum frequency.

P4 Group V/F Control

Function Code	Name	Setting Range
P4.00	V/F curve selection	0-4 【0】

0: Linear V/F curve. It is applicable for normal constant torque load.

1: Multidots curve. It can be defined through setting (P4.03~P4.08).

2~4: Torque—stepdown curve. It is applicable for variable torque load, such as blower, pump and so on. Please refer to following figure.

Note : V_b = Motor rated voltage f_b = Motor rated frequency.

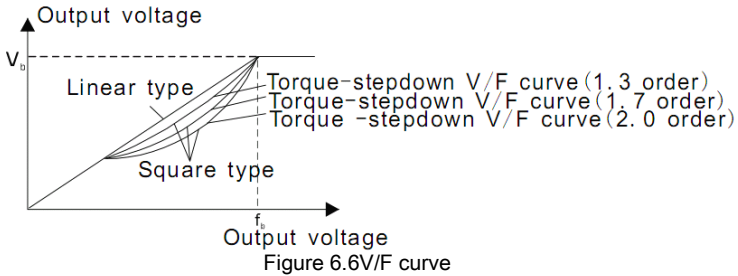

Function Code	Name	Setting Range
P4.01	Torque boost	0.0-10.0% 【0.0%】
P4.02	Torque boost cut-off	0.0-50.0% 【20.0%】

Torque boost will take effect when output frequency is less than cut-off frequency of torque boost (P4.02). Torque boost can improve the torque performance of V/F control at low speed.

The value of torque boost should be determined by the load. The heavier the load, the larger the value is. If the boost is too large, the motor will run in exciting. The efficiency of the motor decreases as the current of the inverter increases and the motor increase the heat-releasing.

When the torque boost is set to 0.0%, the inverter is in the automatic torque boost state. Cut-off point of torque boost : The torque boost is valid under this

point, and the torque boost is invalid when exceeding this set frequency.

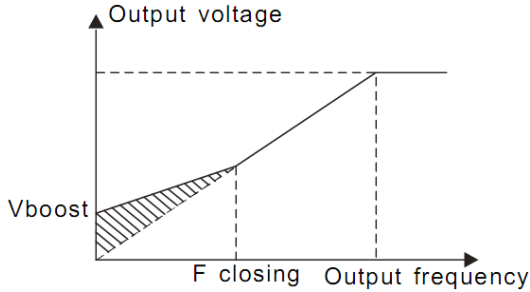

Figure 6.7 Torque boost by hand.

Function Code	Name	Setting Range
P4.03	V/F frequency 1	0.00-P4.05 【0.00Hz】
P4.04	V/F voltage 1	0.0-100.0% 【0.0%】
P4.05	V/F frequency 2	P4.03~P4.07 【0.00Hz】
P4.06	V/F voltage 2	0.0-100.0% 【0.0%】
P4.07	V/F frequency 3	P4.05~P2.02 【0.00Hz】
P4.08	V/F voltage 3	0.0-100.0% 【0.0%】

P4.03~P4.08 are used to set the user-defined V/F curve. The value should be set according to the load characteristic of motor.

Note:

- $V_1 < V_2 < V_3 < \text{rated voltage}$.
- $f_1 < f_2 < f_3 < \text{rated frequency}$.
- The voltage corresponding to low frequency should not be set too high, otherwise it may cause motor overheat or inverter fault.

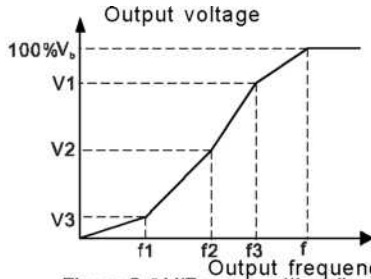

Figure 6.8 V/F curve setting diagram.

Function Code	Name	Setting Range
P4.09	Slip compensation limit	0.0-200% 【0.0%】

The slip compensation function calculates the torque of motor according to the output current and compensates for output frequency. This function is used to improve speed accuracy when operating with a load. P4.09 sets the slip compensation limit as a percentage of motor rated slip; the slip compensation limit is calculated as the formula:

$$P4.09 = fb - n * p / 60$$

Fb= Motor rated frequency (P2.02) N= Motor rated speed (P2.03)

P= Motor poles

Function Code	Name	Setting Range
P4.10	Auto energy saving selection	0~1 【0】

0: Disabled

1: Enabled

While there is a light or empty load such as pumps or fans, it will reduce the inverter output voltage and save energy through detecting the load current.

Function Code	Name	Setting Range
P4.11	Low-frequency threshold of restraining oscillation	0-10 【2】
P4.12	High-frequency threshold of restraining oscillation	0-10 【0】
P4.13	Boundary of restraining oscillation	0.00Hz~P3.03 【30.00Hz】

P4.11 ~P4.12 are only valid in the V/F control mode, When set P4.11 and P4.12 to be 0 the restraining oscillation is invalid. While set the values to be 1~3 will have the effect of restraining oscillation. When the running frequency is lower than P4.13, P4.11 is valid, when the running frequency higher than P4.13, P4.12 is valid.

P5 Group Input Terminals

There are 8 multi-function digital input terminals and 2 analog input terminals in The series inverters.

Function Code	Name	Setting Range
P5.00	HDI selection	0~1 【0】
P5.01	S1 terminal function	0-39 【1】
P5.02	S2 terminal function	0-39 【4】
P5.03	S3 terminal function	0-39 【7】
P5.04	S4 terminal function	0-39 【0】
P5.05	S5 terminal function	0-39 【0】
P5.06	S6 terminal function	0-39 【0】
P5.07	S7 terminal function	0-39 【0】
P5.08	HDI terminal function	0-39 【0】

0: High speed pulse input

1: ON-OFF input

Note: P5.08 is only used when P5.00 is set to be 1.

The meaning of each setting is shown in following table.

Setting value	Function	Description
0	Invalid	Please set unused terminals to be invalid to avoid malfunction
1	Forward	Please refer to description of P5.10.
2	Reverse	
3	3-wire control	Please refer to description of P5.10.
4	Jog forward	Please refer to description of P8.06~P8.08.
5	Jog reverse	
6	Coast to stop	The inverter blocks the output immediately. The motor coasts to stop by its mechanical inertia.
7	Reset fault	Resets faults that have occurred. It has the same function as [STOP/RST] .
8	Pause running	When this terminal takes effect, inverter decelerates to stop and save current status, such as PLC, traverse frequency and PID. When this terminal takes no effect, inverter restores the status
9	External fault input	Stop the inverter and output an alarm when a fault occurs in a peripheral device.
10	Up command	The reference frequency of inverter can be adjusted by UP command and DOWN command.
11	DOWN command	
12	Clear UP/DOWN	These three functions are used to modify the reference frequency through external terminals. UP is the increasing command, DOWN is the decreasing command, and the Clear UP/DOWN is used to restore to the reference frequency given by the frequency command channel.

Setting value	Function	Description			
13	Switch between A and B	Terminal actor P0.10	A	B	A+B
14	Switch between A and A+B		13 valid	B	A
			14 valid	A+B	A
15	Switch between B and A+B		15 valid		A+B
16	Multi-step speed referencel	16 steps speed control can be realized by the combination of these four terminals. For details, please refer to: Multi-step speed reference terminal status and according step value table:			
17	Multi-step speed reference 2				
18	Multi-step speed reference 3				
19	Multi-step speed reference 4				
20	Multi-step speed pause	Keep current step unchanged no matter what the input status of four multi-step speed terminals is.			
21	ACC/DEC time selectionl	4 groups of ACC/DEC time can be selected by the combination of these two terminals.			
22	ACC/DEC time selection 2	ACC/DEC time selection 2	ACC/DEC time selection 1	ACC/DEC time	
		OFF	OFF	ACC/DEC time 0 (P0.11, P0.12)	
		OFF	ON	ACC/DEC time 1 (P8.00, P8.01)	
		ON	OFF	ACC/DEC time 2 (P8.02 ~ P8.03)	
		ON	ON	ACC/DEC time 3 (P8.04 ~ P8.05)	
23	Reset simple PLC when stop	When simple PLC stops, the status of PLC such as running step, running time and running frequency will be cleared when this terminal is enabled.			

Setting value	Function	Description
24	Pause simple PLC	Inverter runs at zero frequency and PLC pauses the timing when this terminal is enabled. If this terminal is disabled, inverter will start and continue the PLC operation from the status before pause.
25	Pause PID	PID adjustment will be paused and inverter keeps output frequency unchanged.
26	Pause traverse operation	Inverter keeps output frequency unchanged. If this terminal is disabled, inverter will continue traverse operation with current frequency.
27	Reset traverse operation	Reference frequency of inverter will be forced as center frequency of traverse operation.
28	Reset counter	Clear the value of counter.
29	Forbid torque control mode	Torque control is forbidden and switch inverter to run in speed control mode.
30	Forbid the function of ACC/DEC	ACC/DEC is invalid and maintains output frequency if it is enabled.
31	Counter input	The pulse input terminal of internal counter. Maximum pulse frequency: 200Hz.
32	UP/DOWN invalid temporarily	UP/DOWN setting is invalid but will not be cleared. When this terminal is disabled, UP/DOWN value before will be valid again.
33~39	Reserved	Reserved

Function Code	Name	Setting Range
P5.09	ON-OFF filter times	0-10 【5】

This parameter is used to set filter strength of terminals (S1 ~ S4 · HDI). When interference is heavy, user should increase this value to prevent malfunction.

Function Code	Name	Setting Range
P5.10	Terminal control mode	0-3 【0】

This parameter defines four different control modes that control the inverter operation through external terminals.

0: 2-wire control mode

1: Integrate enabling with run direction. The defined FWD and REV terminal command determines the direction.

K1	K2	Run command
OFF	OFF	Stop
ON	OFF	FWD
OFF	ON	REV
ON	ON	Maintenance

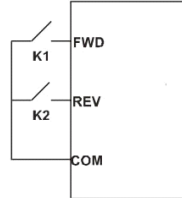

Figure 6.9 2-wire control mode 1.

1: 2-wire control mode 2: START/STOP command is determined by FWD terminal. Run direction is determined by REV terminal.

K1	K2	Run command
OFF	OFF	Stop
ON	OFF	FWD
OFF	ON	Stop
ON	ON	REV

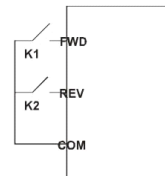

Figure 6.10 2-wire control mode 2.

2: 3-wire control mode

1: SB1: Start button SB2: Stop button (NC)

K: Run direction button

Terminal Sin is the multifunctional input terminal of S1 ~ S7 and HDI. The terminal function should be set to be 3 (3-wire control).

K	Run command
OFF	FWD
ON	REV

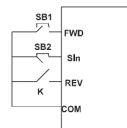

Figure 6.11 3-wire control mode 1.

3: 3-wire control mode 2:

SB1: Forward run button SB2: Stop button (NC)

SB3: Reverse run button Terminal Sin is the multifunctional input terminal of

S1~S7 and HDI. The terminal function should be set to be 3 (3-wire control).

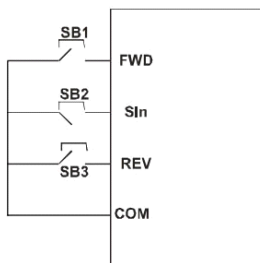

Figure 6.12 3-wire control mode 2.

Note: When 2-wire control mode is active, the inverter will not run in following situation even if FWD/REV terminal is enabled:

- Coast to stop (press [RUN] and [STOP/RST] at the same time).
- Stop command from serial communication.
- FWD/REV terminal is enabled before power on.

Function Code	Name	Setting Range
P5.11	UP/DOWN setting change rate	0.01 ~ 50.00Hz/s 【0.50Hz/s】

This parameter is used to determine how fast UP/DOWN setting changes.

Function Code	Name	Setting Range
P5.12	AI1 lower limit	-10.00~10.00V 【0.00V】
P5.13	AI1 lower limit corresponding setting	-100.0-100.0% 【0.0%】
P5.14	AI1 upper limit	-10.00-10.00V 【10.00V】
P5.15	AI1 upper limit corresponding setting	-100.0-100.0 【100.0%】
P5.16	AI1 filter time constant	0.00-10.00s 【0.10s】

These parameters determine the relationship between analog input voltage and the corresponding setting value. When the analog input voltage exceeds the range between lower limit and upper limit, it will be regarded as the upper limit or lower limit.

The analog input AI1 can only provide voltage input, and the range is -10V~10V. For different applications, the corresponding value of 100.0% analog setting is different. For details, please refer to description of each application.

Note: AI1 lower limit must be less or equal to AI1 upper limit.

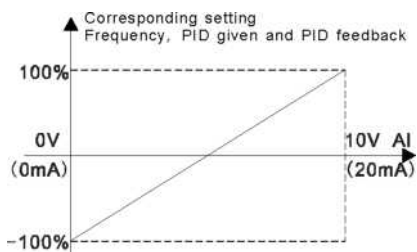

Figure 6.13 Relationship between AI and corresponding setting.

AI1 filter time constant is effective when there are sudden changes or noise in the analog input signal. Responsiveness decreases as the setting increases.

Function Code	Name	Setting Range
P5.17	AI2 lower limit	0.00-10.00V 【0.00V】
P5.18	AI2 lower limit corresponding setting	-100.0-100.0 【0.0%】
P5.19	AI2 upper limit	0.00-10.00V 【10.00V】
P5.20	AI2 upper limit corresponding setting	-100.0-100.0 【100.0%】
P5.21	AI2 filter time constant	0.00-10.00s 【0.10s】

Please refer to description of AI1. When AI2 is set as 0~20mA input, the corresponding voltage range is 0~5V.

Function Code	Name	Setting Range
P5.22	HDI lower limit	0.00~ 50.00kHz 【[0.00kHz]】
P5.23	HDI lower limit corresponding setting	-100.0-100.0 【0.0%】
P5.24	HDI upper limit	0.00~ 50.00kHz 【50.00kHz】
P5.25	HDI upper limit corresponding setting	-100.0~ 100.0 【100.0%】
P5.26	HDI filter time constant	0.00-10.00s 【0.10s】

The description of P5.22~P5.26 is similar to AI1

P6 Group Output Terminals

There are 2 multi-function relay output terminals, 1 HDO terminal and 2 multi-function analog output terminals in the series inverters.

Function Code	Name	Setting Range
P6.00	HDO selection	0~1 【1】

0: High-speed pulse output: The maximum pulse frequency is 50.0 kHz. Please refer to description of P6.06.

1: ON-OFF output: Please refer to description of P6.01.

Note: The output of HDO terminal is OC (open collector) output.

Function Code	Name	Setting Range
P6.01	HDO ON-OFF output selection	0-20 【6】
P6.02	Relay 1 output selection	0-20 【4】
P6.03	Relay 2 output selection	0-20 【1】

OC/Relay output functions are indicated in the following table:

Setting Value	Function	Description
0	No output	Output terminal has no function.
1	Running	ON: Run command is ON or voltage is being output.
2	Run forward	ON: During forward run.
3	Run reverse	ON: During reverse run.
4	Fault output	ON: Inverter is in fault status.
5	FDT reached	Please refer to description of P8.21 - P8.22.
6	Frequency reached	Please refer to description of P8.23.
7	Zero speed running	ON: The running frequency of inverter and setting frequency are zero.
8	Preset count value reached	Please refer to description of P8.18.
9	Specified count value reached	Please refer to description of P8.19.
10	Overload pre-warming of inverter	According to the "pre-alarm point of the inverter" , , it will output ON signal when exceeding the pre-alarm time.
11	Simple PLC step completed	After simple PLC completes one step, inverter will output ON signal for 500ms.
12	PLC cycle completed	After simple PLC completes one cycle, inverter will output ON signal for 500ms.
13	Running time reached	ON: The accumulated running time of inverter reaches the value of P8.20.
14	Upper frequency limit reached	ON: Running frequency reaches the value of P0.04.
15	Lower frequency limit reached	ON: Running frequency reaches the value of P0.05.
16	Ready	ON: Inverter is ready (no fault, power is ON).
17-20	Reserved	Reserved

Function Code	Name	Setting Range
P6.04	AO1 function selection	0-10 【0】
P6.05	AO2 function selection	0-10 【0】
P6.06	HDO function selection	0-10 【0】

AO/HDO output functions are indicated in the following table:

Setting Value	Function	Range
0	Running frequency	0 ~ Maximum frequency
1	Reference frequency	0 ~ Maximum frequency
2	Running speed	0 ~ 2* rated synchronous speed of motor
3	Output current	0 ~ 2* inverter rated current
4	Output voltage	0 ~ 1.5* inverter rated voltage
5	Output power	0 ~ 2* rated power
6	Setting torque	0 ~ 2*rated current of motor
7	Output torque	0 ~ 2*rated current of motor
a	AI1 voltage	-10 ~ 10V
9	AI2 voltage/current	0~10V/0 ~ 20mA
10	HDI frequency	0.1 ~ 50.0kHz

Function Code	Name	Setting Range
P6.07	AO1 lower limit	0.0-100.0% 【0.0%】
P6.08	AO1 lower limit corresponding output	0.00 – 10.00V 【0.00V】
P6.09	AO1 upper limit	0.0-100.0% 【100.0%】
P6.10	AO1 upper limit corresponding output	0.00-10.00V 【10.00V】

These parameters determine the relationship between analog output voltage/current and the corresponding output value. When the analog output value exceeds the range between lower limit and upper limit, it will output the upper limit or lower limit.

When AO1 is current output, 1 mA is corresponding to 0.5V.

For different applications, the corresponding value of 100.0% analog output is different. For details, please refer to description of each application.

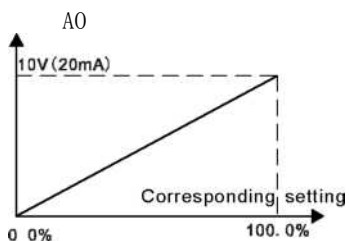

Figure 6.14 Relationship between AO and corresponding setting.

Function Code	Name	Setting Range
P6.11	AO2 lower limit	0.0-100.0% 【0.0%】
P6.12	AO2 lower limit corresponding output	0-10.00V 【0.00V】
P6.13	AO2 upper limit	0.0-100.0% 【100.0%】
P6.14	AO2 upper limit corresponding output	0.00-10.00V 【10.00V】
P6.15	HDO lower limit	0.0-100.0% 【0.0%】
P6.16	HDO lower limit corresponding output	0.00~50.00kHz 【0.00kHz】
P6.17	HDO upper limit	0.0-100.0% 【100.0%】
P6.18	HDO upper limit corresponding output	0.00~50.00kHz 【50.00kHz】

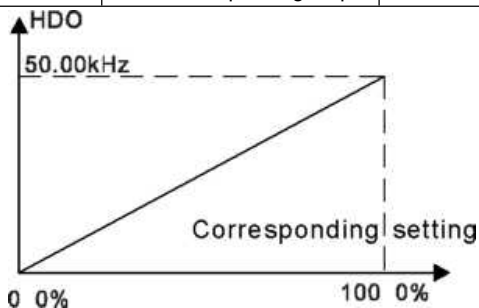

Figure 6.15 Relationship between HDO and corresponding setting.

P7 Group Display Interface

Function Code	Name	Setting Range
P7.00	User password	0-65535 【0】

The password protection function will be valid when P7.00 is set to be any nonzero data. When P7.00 is set to be 00000, user's password set before will be cleared and the password protection function will be disabled.

After the password has been set and becomes valid, the user can not access menu if the user's password is not correct. Only when a correct user's password is input, the user can see and modify the parameters. Please keep user's password in mind.

The password protection becomes valid in 1 minute after quitting from the function code editing state. Press [PRG/ESC] again to the function code editing state, "0.0.0.0.0" will be displayed. Unless using the correct password, the operators cannot enter it.

Function Code	Name	Setting Range
P7.01	Reserved	Reserved
P7.02	Reserved	Reserved
P7.03	[QUICK/JOG] function selection	0-4 【0】

[QUICK/JOG] is a multifunctional key, whose function can be defined by the value

0. Display status switching

1. 1: Jog: Press [QUICK/JOG], the inverter will jog.

2: FWD/REV switching: Press [QUICK/JOG], the running direction of inverter will reverse. It is only valid if P0.03 is set to be 0.

3: Clear UP/DOWN setting: Press [QUICK/JOG] the UP/DOWN setting will be cleared.

4. Quick debugging mode

Function Code	Name	Setting Range
P7.04	[STOP/RST] function selection	0-3 【0】

- 0: Valid when keypad control (P0.02=0)
- 1: Valid when keypad or terminal control (P0.02=0 or 1)
- 2: Valid when keypad or communication control (P0.02=0 or 2)
- 3: Always valid

Note:

- The value of P7.04 only determines the STOP function of [STOP/RST]
- The RESET function of [STOP/RST] is always valid.

Function Code	Name	Setting Range
P7.05	Keypad display selection	0-3 【0】

- 0: When external keypad exists, local keypad will be invalid.
- 1: Local and external keypad display simultaneously, only the key of external keypad is valid.
- 2: Local and external keypad display simultaneously, only the key of local keypad is valid.
- 3: Local and external keypad display simultaneously, both keys of local and external keypad are valid.

Note: This function should be used cautiously, otherwise it may cause malfunction.

Function Code	Name	Setting Range
P7.06	Running status display selection 1	0~0xFFFF 【0x07FF】
P7.07	Running status display selection 2	0~0xFFFF 【0】

P7.06 and P7.07 define the parameters that can be displayed by LED in running status. If Bit is 0, the parameter will not be displayed; If Bit is 1, the parameter will be displayed. Press [> /SHIFT] to scroll through these parameters in right order. Press [DATA/ENT] + [QUICK/JQG] to scroll through these parameters in left order.

The display content corresponding to each bit of P7.06 is described in the following table:

BIT7	BIT6	BIT5	BIT4	BIT3	BIT2	BIT11	BIT0
Output power	Line speed	Rotation speed	Output current	Output voltage	DC bus voltage	Reference frequency	Running frequency

BIT15	BIT14	BIT13	BIT12	BIT11	BIT10	BIT9	BIT8
Step No. of PLC or multi-step	Count value	Torque setting value	Output terminal status	Input terminal status	PID feedback	PID preset	Output torque

For example, if user wants to display output voltage, DC bus voltage, Reference frequency, Output frequency, Output terminal status, the value of each bit is as the following table:

BIT7	BIT6	BIT5	BIT4	BIT3	BIT2	BIT1	BIT0
0	0	0	0	1	1	1	1
BIT15	BIT14	BIT13	BIT12	BIT11	BIT10	BIT9	BIT8
0	0	0	1	0	0	0	0

The value of P7.06 is 100Fh.

Note: I/O terminal status is displayed in decimal.

For details, please refer to description of P7.23 and P7.24.

The display content corresponding to each bit of P7.07 is described in the following table:

BIT7	BIT6	BIT5	BIT4	BIT3	BIT2	BIT1	BIT0
Reserved	Reserved	Reserved	Load percentage of inverter	Load percentage of motor	HDI frequency	AI2	AM
BIT15	BIT14	BIT13	BIT12	BIT11	BIT10	BIT9	BIT8
Reserved	Reserved	Reserved	Reserved	Reserved	Reserved	Reserved	Reserved

Function Code	Name	Setting Range
P7.08	Stop status display selection	0~0xFFFF 【0x07FF】

P7.08 determines the display parameters in stop status. The setting method is similar with P7.06.

The display content corresponding to each bit of P7.08 is described in the following table:

BIT7	BIT6	BIT5	BIT4	BIT3	BIT2	BIT1	BIT0
AI2	AI1	PID feedback	PID preset	Output terminal status	Input terminal status	DC bus voltage	Reference frequency
BIT15	BIT14	BIT13	BIT12	BIT11	BIT10	BIT9	BIT8
Reserved	Reserved	Reserved	Reserved	Reserved	Torque setting value	Step No. of PLC or multi-step	HDI frequency

Function Code	Name	Setting Range
P7.09	Coefficient of rotation speed	0.1 ~ 999.9% 【100.0%】

This parameter is used to calibrate the bias between actual mechanical speed and rotation speed. The formula is as below:

Actual mechanical speed = 120 * output frequency * P7.09 / Number of poles of motor.

Function Code	Name	Setting Range
P7.10	Coefficient of line speed	0.1-999.9% 【100.0%】

This parameter is used to calculate the line speed based on actual mechanical speed. The formula is as below:

Line speed - actual mechanical speed * P7.10

Function Code	Name	Setting Range
P7.11	Rectify module temperature	0~100.0°C
P7.12	IGBT module temperature	CM00.CTC
P7.13	Software version	
P7.14	Inverter rated power	0~3000kW 【Depend on model】
P7.15	Inverter rated current	0.0-6000A 【Depend on mode】
P7.16	Accumulated running time	0 ~ 65535h

Rectify module temperature: Indicates the temperature of rectify module. Overheat protection point of different model may be different.

IGBT module temperature: Indicates the temperature of IGBT module. Overheat protection point of different model may be different.

Software version: Indicates current software version of DSP.

Accumulated running time: Displays accumulated running time of inverter.

Note: Above parameters are read only.

Function Code	Name	Setting Range
P7.17	Third latest fault type	0-25

Function Code	Name	Setting Range
P7.18	Second latest fault type	0-25
P7.19	Latest fault type	0-25

These parameters record three recent fault types. 0 means there is no fault and 0~25 means there are 25 faults. For details, please refer to fault analysis.

Function Code	Name	Setting Range
P7.20	Output frequency at current fault	
P7.21	Output current at current fault	
P7.22	DC bus voltage at current fault	
P7.23	Input terminal status at current fault	
P7.24	Output terminal status at current fault	

This value is displayed as decimal. This value records ON-OFF input terminal status at current fault. The meaning of each bit is as below:

BIT7	BIT6	BIT5	BIT4
HDI	S7	S6	S5
BIT3	BIT2	BIT1	BIT0
S4	S3	S2	S1

1 indicates corresponding input terminal is ON, while 0 indicates OFF. This value records output terminal status at current fault.

This value is displayed as decimal. The meaning of each bit is as below:

BIT3	BIT2	BIT1	BIT0
Reserved	RO2	RO1	HDO

Function Code	Name	Setting Range
P8.00	Acceleration time 1	0.1 ~ 3600.0s 【Depend on model】

1 indicates corresponding output terminal is ON, while 0 indicates OFF. Notice: This value is displayed as decimal.

P8 Group Enhanced Function

By means of setting skip frequency, the inverter can keep away from the mechanical resonance with the load. P8.09 and P8.10 are centre value of frequency to be skipped.

Notice:

P8.01	Deceleration time 1	0.1 ~3600.0s 【Depend on model】
P8.02	Acceleration time 2	0.1 ~ 3600.0s 【Depend on model】
P8.03	Deceleration time 2	0.1 ~ 3600.0s 【Depend on model】
P8.04	Acceleration time 3	0.1 ~ 3600.0s 【Depend on model】
P8.05	Deceleration time 3	0.1 ~3600.0s 【Depend on model】

ACC/DEC time can be selected among P0.11, P0.12 and the above three groups. Their meanings are the same. Please refer to the relative instructions of P0.11 and P0.12.

Select the ACC/DEC time 0~3 through the different combination of the multi-function digital terminals when the inverter runs.

For details, please refer to description of P0.11 and P0.12.

Function Code	Name	Setting Range
P8.06	Jog reference	0.00-P0.03 【Depend on model】
P8.07	Jog acceleration time	0.1 ~ 3600.0s 【Depend on model】
P8.08	Jog deceleration time	0.1 ~ 3600.0s 【Depend on model】
P8.09	Skip Frequency 1	0.00-P0.03 【0.00Hz】
P8.10	Skip Frequency 2	0.00-P0.03 【0.00Hz】
P8.11	Skip frequency bandwidth	0.00-P0.03 【0.00Hz】

- If P8.11 is 0, the skip function is invalid.
- _ If both P8.09 and P8.10 are 0 , the skip function is invalid no matter what P8.11 is.
- Operation is prohibited within the skip frequency bandwidth, but changes during acceleration and deceleration are smooth without skip.

The relation between output frequency and reference frequency is shown in following figure.

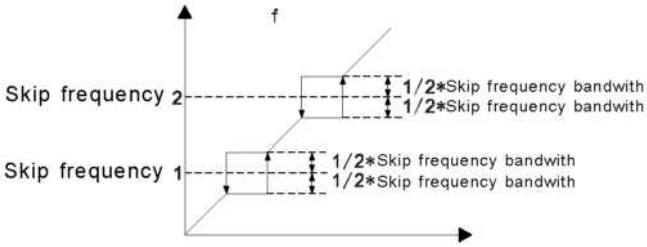

Figure 6.16 Skip frequency diagram.

Function Code	Name	Setting Range
P8.12	Traverse amplitude	0.0-100.0% 【0.0%】
P8.13	Jitter frequency	0.0-50.0% 【0.0%】
P8.14	Rise time of traverse	0.1 ~3600.0s 【5.0s】
P8.15	Fall time of traverse	0.1 ~3600.0s 【5.0s】

Traverse function applies to the industries where need the traverse and convolution function such as textile and chemical fiber industries.

The traverse function means that the output frequency of the inverter is fluctuated with the set frequency as its center. The route of the running frequency is illustrated as below, of which the traverse is set by P8.12 and when P8.12 is set as 0 , the traverse is 0 with no function.

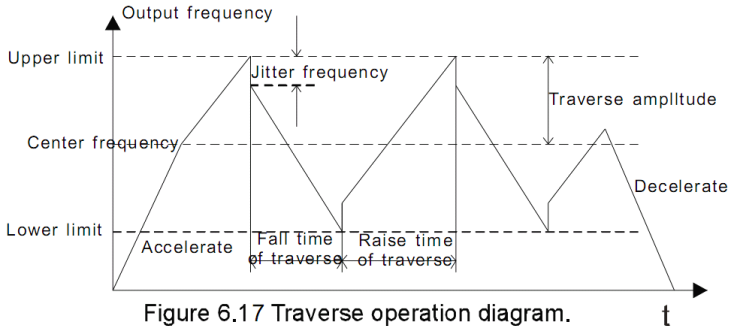

Figure 6.17 Traverse operation diagram.

Traverse range : The traverse running is limited by upper and low frequency.

The traverse range relative to the center frequency:traverse range $AW = \text{center frequency} \times \text{traverse range P8.12}$.

Sudden jumping frequency = traverse range AWX sudden jumping frequency

range P8.13. When run at the traverse frequency, the value which is relative to the sudden jumping frequency.

The raising time of the traverse frequency : The time from the lowest point to the highest one.

The declining time of the traverse frequency : The time from the highest point to the lowest one.

Function Code	Name	Setting Range
P8.16	Auto reset times	0 ~ 3 【0】
P8.17	Reset interval	0.1 ~ 100.0s 【1.0s】

The times of the fault reset: the inverter set the fault reset times by selecting this function. If the reset times exceeds this set value, the inverter will stop for the fault and wait to be repaired.

The interval time of the fault reset : The interval between the time when the fault occurs and the time when the reset action occurs.

Function Code	Name	Setting Range
P8.18	Preset count value	P8.19~65535 【0】
P8.19	Specified count value	0 ~ P8.18 【0】

The count pulse input channel can be S1 ~ S4 ($\leq 200\text{Hz}$) and HDI.

If function of output terminal is set as preset count reached, when the count value reaches preset count value (P8.18) , it will output an ON-OFF signal. Inverter will clear the counter and restart counting.

If function of output terminal is set as specified count reached, when the count value reaches specified count value (P8.19), it will output an ON-OFF signal until the count value reaches preset count value (P8.18). Inverter will clear the counter and restart counting.

Note:

- Specified count value (P8.19) should not be greater than preset count value (P8.18).
- Output terminal can be RO1, RO2 or HDO.

This function is shown as following figure.

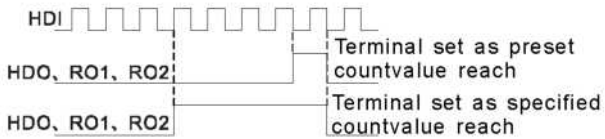

Figure 6.18 Timing chart for preset and specified count reached.

Function Code	Name	Setting Range
P8.20	Preset running time	0~65535h 【65535h】

Pre-set running time of the inverter.

When the accumulative running time achieves the set time, the multi-function digital output terminals will output the signal of "running time arrival".

Function Code	Name	Setting Range
P8.21	FDT level	0.00-P0.03 【50.00Hz】
P8.22	FDT lag	0.0-100.0 【5.0%】

When the output frequency reaches a certain preset frequency (FDT level), output terminal will output an ON-OFF signal until output frequency drops below a certain frequency of FDT level (FDT level - FDT lag), as shown in following figure.

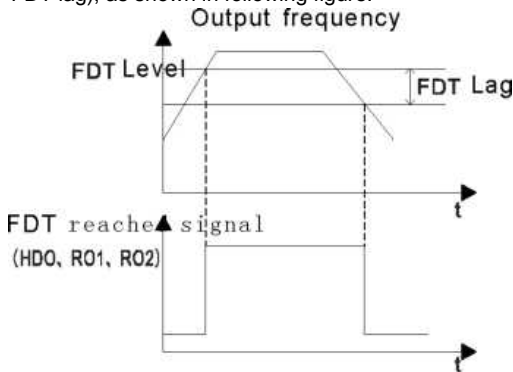

Figure 6.19 FDT level and lag diagram.

Function Code	Name	Setting Range
P8.23	Frequency arrive detecting range	0.0-100.0% 【0.0%】

When output frequency is within the detecting range of reference frequency, an ON-OFF signal will be output. The function can adjust the detecting range.

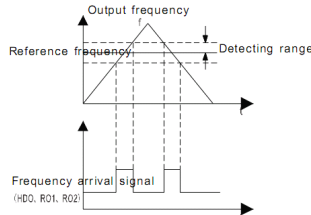

Figure 6.20 Frequency arriving detection diagram.

Function Code	Name	Setting Range
P8.24	Droop control	0.00-10.00Hz 【0.00Hz】

When several motors drive the same load, each motor's load is different because of the difference of motor's rated speed. The load of different motors can be balanced through droop control function which makes the speed droop along with load increase.

When the motor outputs rated torque, actual frequency drop is equal to P8.24. User can adjust this parameter from small to big gradually during commissioning. The relation between load and output frequency is in the following figure.

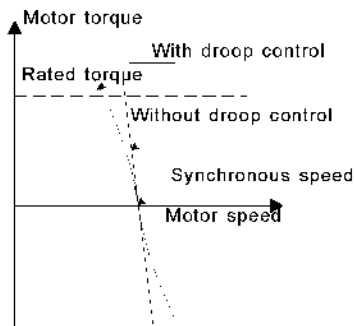

Figure 6.21 Droop control diagram.

Function Code	Name	Setting Range
P8.25	Brake threshold voltage	115.0-140.0% 【Depand on Model】

When the DC bus voltage is greater than the value of P8.25, the inverter will start dynamic braking.

Note:

_ Factory setting is 120% if rated voltage of inverter is 220V.

- Factory setting is 130% if rated voltage of inverter is 380V.
- The value of P8.25 is corresponding to the DC bus voltage at rated input voltage.

Function Code	Name	Setting Range
P8.26	Cooling fan control	0~1 【0】

0: Auto stop mode: The fan keeps working when the inverter is running. When the inverter stops, whether the fan works or not depends on the module temperature of inverter.

1: The fan keeps working when powering on.

Function Code	Name	Setting Range
P8.27	Overmodulation	0~1 【0】

0: the function is invalid

1: the function is valid

The function is applicable in the instance of low network voltage or heavy load for a long time , inveter raises the output voltage with rising utilization rate of bus voltage.

Function Code	Name	Setting Range
P8.28	PWM mode	0-2 【0】

The features of each mode, please refer the following table:

Mode	Noise in lower frequency	Noise in higher frequency	Others
PWM mode 1	Low	high	
PWM mode 2	low		Need to be derated, because of higher temperature rise.
PWM mode 3	high		Be more effective to restrain the oscillation

P9 Group PID Control

PID control is a common used method in process control, such as flow, pressure and temperature control. The principle is firstly to detect the bias between preset value and feedback value, then calculate output frequency of inverter according to proportional gain, integral and differential time. Please refer to following figure.

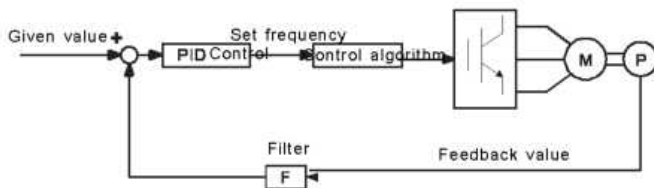

Figure 6.22 PID control diagram.

Note: To make PID take effect, P0.07 must be set to be 6.

Function Code	Name	Setting Range
P9.00	PID preset source selection	0-5 【0】

0:keypad

1: AI1

2: AI2

3: HDI

4: Multi-step

5: Communication

When P0.07=6, this function is valid. The parameter determines the target given channel during the PID procures.

These parameters are used to select PID preset and feedback source.

Note:

- Preset value and feedback value of PID are percentage value.
- 100% of preset value is corresponding to 100% of feedback value.
- Preset source and feedback source must not be same, otherwise PID will be malfunction.

Function Code	Name	Setting Range
P9.01	Keypad PID preset	0.0-100.0% 【0.0%】

Set the parameter when P9.00=0.

The basic value of this parameter is the feedback value.

Function Code	Name	Setting Range
P9.02	PID feedback source selection	0-4 【0】

0: AI1

1: AI2

2: AI1+AI2

3: HDI

4: Communication

This parameter is used to select PID feedback source.

The given channel and the feedback channel can not coincide, otherwise, PID can not control effectively.

Function Code	Name	Setting Range
P9.03	PID output characteristic	0~1 【0】

0 : Positive. When the feedback value is greater than the preset value, output frequency will be decreased, such as tension control in winding application.

1: Negative. When the feedback value is greater than the preset value, output frequency will be increased, such as tension control in unwinding application.

Function Code	Name	Setting Range
P9.04	Proportional gain (Kp)	0.00-100.00 【0.10】
P9.05	Integral time (Ti)	0.00-100.00s 【0.10】
P9.06	Differential time (Td)	0.00-100.00s 【0.10】

Optimize the responsiveness by adjusting these parameters while driving an actual load.

Adjusting PID control:

Use the following procedure to activate PID control and then adjust it while monitoring the response.

2. Enabled PID control (P0.07=6)
3. Increase the proportional gain (Kp) as far as possible without creating oscillation.
4. Reduce the integral time (Ti) as far as possible without creating oscillation.
5. Increase the differential time (Td) as far as possible without creating oscillation. Making fine adjustments:

First set the individual PID control constants, and then make fine adjustments.

- Reducing overshooting

If overshooting occurs, shorten the differential time and lengthen the integral time.

- Rapidly stabilizing control status

To rapidly stabilize the control conditions even when overshooting occurs, shorten the integral time and lengthen the differential time.

- Reducing long-cycle oscillation

If oscillation occurs with a longer cycle than the integral time setting, it means that integral operation is strong. The oscillation will be reduced as the integral time is lengthened.

- Reducing short-cycle oscillation

If the oscillation cycle is short and oscillation occurs with a cycle approximately the same as the differential time setting, it means that the differential operation is strong. The oscillation will be reduced as the differential time is shortened.

If oscillation cannot be reduced even by setting the differential time to 0, then either lower the proportional gain or raise the PID primary delay time constant.

Function Code	Name	Setting Range
P9.07	Sampling cycle (T)	0.01-100.00s 【0.1s】
P9.08	Bias limit	0.00 ~ 100.00% 【0.0%】

Sampling cycle T refers to the sampling cycle of feedback value. The PI regulator calculates once in each sampling cycle. The bigger the sampling cycle is, the slower the response is.

Bias limit defines the maximum bias between the feedback and the preset. PID stops operation when the bias is within this range. Setting this parameter correctly is helpful to improve the system output accuracy and stability.

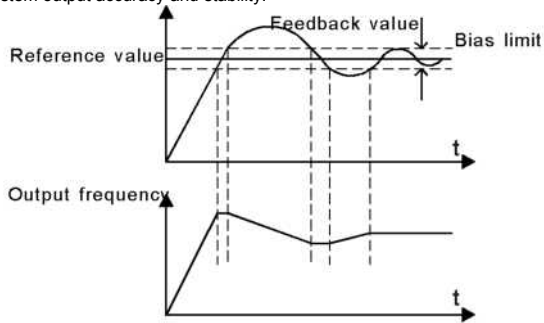

Figure 6.23 Relationship between bias limit and output frequency.

Function Code	Name	Setting Range
P9.09	Feedback lost detecting value	0.0-100.0% 【0.0%】
P9.10	Feedback lost detecting time	0.0~3600.0s 【1.0s】

When feedback value is less than P9.09 continuously for the period determined by P9.10, the inverter will alarm feedback lost failure (PIDE).

Note: 100% of P9.09 is the same as 100% of P9.01.

PA Group Simple PLC and Multi-step Speed Control

Simple PLC function can enable the inverter to change its output frequency and directions automatically according to programmable controller PLC. For multi-step speed function, the output frequency can be changed only by multi-step terminals.

Note:

- Simple PLC has 16 steps which can be selected.
- If P0.07 is set to be 5, 16 steps are available for multi-step speed.

Otherwise

only 15 steps are available (step 1~15).

Function Code	Name	Setting Range
PA.00	Simple PLC mode	0-2 【0】

0: Stop after one cycle: Inverter stops automatically as soon as it completes one cycle, and it needs run command to start again.

1: Hold last frequency after one cycle: Inverter holds frequency and direction of last step after one cycle.

2: Circular run: Inverter continues to run cycle by cycle until receive a stop command.

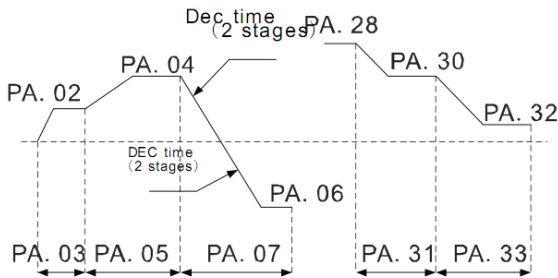

Figure 6.24 Simple PLC operation diagram.

Function Code	Name	Setting Range
PA.01	Simple PLC status saving after power off	0~1 【0】

0: Power loss without memory

1 : Power loss memory

PLC record the running stage and frequency when power loss.

Function Code	Name	Setting Range
PA.02	Multi-step speed 0	-100.0-100.0% 【0.0%】
PA.03	0 th Step running time	0.0~6553.5s 【0.0s】
PA.04	Multi-step speed 1	-100.0-100.0% 【0.0%】
PA.05	1 st Step running time	0.0~6553.5s 【0.0s】
PA.06	Multi-step speed 2	-100.0-100.0% 【0.0%】
PA.07	2nd Step running time	0.0~6553.5s 【0.0s】
PA.08	Multi-step speed 3	-100.0-100.0% 【0.0%】
PA.09	3rd Step running time	ao~6553.5s 【0.0s】
PA.10	Multi-step speed 4	-100.0-100.0% 【0.0%】
PA.11	4th Step running time	ao~6553.5s 【0.0s】
PA.12	Multi-step speed 5	-100.0-100.0% 【0.0%】
PA.13	5th Step running time	0.0~6553.5s 【0.0s】
PA.14	Multi-step speed 6	-100.0-100.0% 【0.0%】
PA.15	6th Step running time	0.0~6553.5s 【0.0s】
PA.16	Multi-step speed 7	-100.0-100.0% 【0.0%】
PA.17	7th Step running time	0.0~6553.5s 【0.0s】
PA.18	Multi-step speed 8	-100.0-100.0% 【0.0%】
PA.19	8th Step running time	0.0~6553.5s 【0.0s】
PA.20	Multi-step speed 9	-100.0-100.0% 【0.0%】
PA.21	9th Step running time	0.0~6553.5s 【0.0s】
PA.22	Multi-step speed 10	-100.0-100.0% 【0.0%】
PA.23	10th Step running time	0.0~6553.5s 【0.0s】
PA.24	Multi-step speed 11	-100.0-100.0% 【0.0%】
PA.25	11th Step running time	0.0~6553.5s 【0.0s】
PA.26	Multi-step speed 12	-100.0-100.0% 【0.0%】
PA.27	12th Step running time	0.0~6553.5s 【0.0s】
PA.28	Multi-step speed 13	-100.0-100.0% 【0.0%】
PA.29	13th Step running time	0.0~6553.5s 【0.0s】
PA.30	Multi-step speed 14	-100.0-100.0% 【0.0%】
PA.31	14th Step running time	0.0~6553.5s 【0.0s】
PA.32	Multi-step speed 15	-100.0-100.0% 【0.0%】
PA.33	15th Step running time	0.0~6553.5s 【0.0s】

100.0% of the frequency setting corresponds to the Max. Frequency.

When selecting simple PLC running, set PA.02~PA.33 to define the running and direction of all stages.

Note : The symbol of multi-stage determines the running direction of simple PLC.

The negative value means reverse rotation.

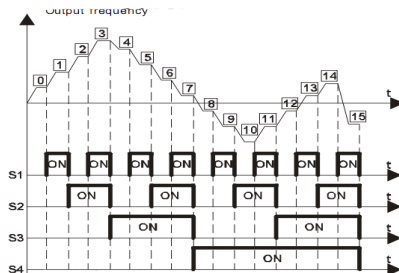

Figure 6.25 Multi-steps speed operation diagram.

Multi-stage speeds are in the range of F_{min} ~ F_{max} and it can be set continuously. The series inverters can set 16 stages speed, selected by the combination of multi-stage terminals S1 · S2 · S3, S4, corresponding to the speed 0 to speed 15.

When $S1=S2=S3=S4=OFF$, the frequency input manner is selected via code P0.06 or P0.07. When all $S1=S2=S3=S4$ terminals aren't off, it runs at multi-stage which takes precedence of keypad, analog value, high-speed pulse, PLC, communication frequency input. Select at most 16 stages speed via the combination code of S1 · S2, S3, and S4.

The start-up and stopping of multi-stage running is determined by function code PO.01, the relationship between S1、S2、S3、S4 terminals and multi-stage speed is as following:

S1	OFF	ON	OFF	ON	OFF	ON	OFF	ON
S2	OFF	OFF	ON	ON	OFF	OFF	ON	ON
S3	OFF	OFF	OFF	OFF	ON	ON	ON	ON
S4	OFF	OFF	OFF	OFF	OFF	OFF	OFF	OFF
stage	0	1	2	3	4	5	6	7
S1	OFF	ON	OFF	ON	OFF	ON	OFF	ON
S2	OFF	OFF	ON	ON	OFF	OFF	ON	ON
S3	OFF	OFF	OFF	OFF	ON	ON	ON	ON
S4	ON	ON	ON	ON	ON	ON	ON	ON
stage	8	9	10	11	12	13	14	15

Function Code	Name	Setting Range
PA.34	ACC/DEC time selection for step 0~7	0~0xFFFF 【0】
PA.35	ACC/DEC time selection for step 8~15	0~0xFFFF 【0】

These parameters are used to determine the ACC/DEC time from one step to next step. There are four ACC/DEC time groups.

Function Code	Binary Digit		Step No.	ACC/DEC	ACC/D EC	ACC/D EC	ACC/DEC Time 3
PA.34	BIT1	BIT0	0	00	01	10	11
	BIT3	BIT2	1	00	01	10	11
	BIT5	BIT4	2	00	01	10	11
	BIT7	BIT6	3	00	01	10	11
	BIT9	BIT8	4	00	01	10	11
	BIT11	BIT10	5	00	01	10	11
	BIT13	BIT12	6	00	01	10	11
PA.35	BIT15	BIT14	7	00	01	10	11
	BIT1	BIT0	8	00	01	10	11
	BIT3	BIT2	9	00	01	10	11
	BIT5	BIT4	10	00	01	10	11
	BIT 7	BIT6	11	00	01	10	11
	BIT9	BIT8	12	00	01	10	11
	BIT11	BIT10	13	00	01	10	11
BIT13	BIT12	14	00	01	10	11	
	BIT15	BIT14	15	00	01	10	11

After the users select the corresponding ACC/DEC time, the combining 16 binary bit will change into decimal bit, and then set the corresponding function codes.

Function Code	Name	Setting Range
PA.36	Simple PLC restart selection	0-2 【0】

0: Restart from step 0: If the inverter stops during running (due to stop command or fault), it will run from step 0 when it restarts.

1: Continue from interrupted step: If the inverter stops during running (due to stop command or fault), it will record the running time of current step. When inverter restarts, it will resume from interrupted time automatically. For details, please refer to following figure.

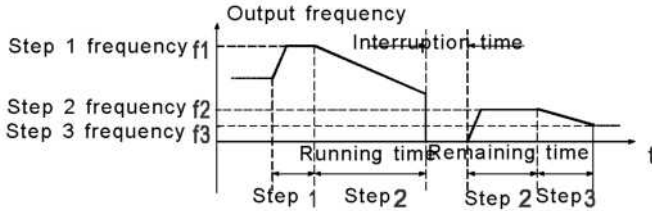

Figure 6.26 Simple PLC continues from interrupted step.

Function Code	Name	Setting Range
PA.37	Time unit	0~1 [0]

0 : Seconds

1 : Minutes

This parameter determines the unit of x step running time.

PB Group Protection Function

Function Code	Name	Setting Range
Pb.00	Input phase-failure protection	0~1 [1]
Function Code	Name	Setting Range
Pb.01	Output phase-failure protection	0~1 [1]

0: Disable

1: Enable

Input phase loss protection: select whether to protect the input phase loss

Function Code	Name	Setting Range
Pb.02	Motor overload protection	0-2 [2]

0: For normal motor, the lower the speed is, the poorer the cooling effect is. Based on this reason, if output frequency is lower than 30Hz, inverter will reduce the motor overload protection threshold to prevent normal motor from overheat.

1: Common motor (with low speed compensation). As the cooling effect of the common motor is weakened at low speed, the corresponding electronic heating

protection is adjusted. The low speed compensation means decrease the motor overload protection threshold whose frequency is below 30Hz.

2: Variable frequency motor (without low speed compensation). As the cooling effect of variable frequency motor has nothing to do with running speed, it is not required to adjust the motor overload protection threshold.

Function Code	Name	Setting Range
Pb.03	Motor overload protection current	20.0-120.0% 【 100.0% 】

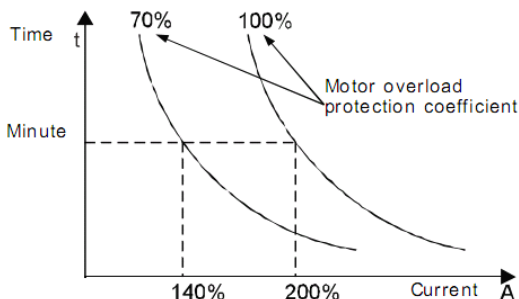

Figure 6.27 Motor overload protection curve.

The value can be determined by the following formula:

Motor overload protection current = (Maximum load current / inverter rated current) * 100%

Note:

- This parameter is normally used when rated power of inverter is greater than rated power of motor.
- Motor overload protection time: 60s with 200% of rated current. For details, please refer to above figure.

Function Code	Name	Setting Range
Pb.04	Threshold of trip-free	70.0-110.0% 【 80.0% 】
Pb.05	Decrease rate of trip-free	0.00Hz~P0.03 【 0.00Hz 】

100% of Pb.04 corresponds to the standard bus voltage.

If Pb.05 is set to be 0 , the trip-free function is invalid.

Trip-free function enables the inverter to perform low-voltage compensation when DC bus voltage drops below Pb.04. The inverter can continue to run without tripping by reducing its output frequency and feedback energy via motor.

Note: If Pb.05 is too big, the feedback energy of motor will be too large and may

cause over-voltage fault. If Pb.05 is too small, the feedback energy of motor will be too small to achieve voltage compensation effect. So please set Pb.05 according to load inertia and the actual load.

Function Code	Name	Setting Range
Pb.06	Over-voltage stall protection	0~1 【1】
Pb.07	Over-voltage stall protection	110-150% 【130.0%】

point

0: Disabled 1: Enabled

During deceleration, the motor's decelerating rate may be lower than that of inverters output frequency due to the load inertia. At this time, the motor will feed the energy back to the inverter, resulting in rise of DC bus voltage rise. If no measures taken, the inverter will trip due to overvoltage.

During deceleration, the inverter detects DC bus voltage and compares it with over-voltage stall protection point. If DC bus voltage exceeds Pb.07, the inverter will stop reducing its output frequency. When DC bus voltage become lower than Pb.07, the deceleration continues, as shown in following figure.

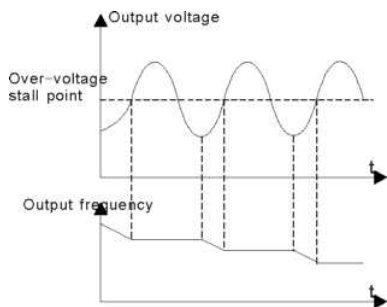

Figure 6.28 Over-voltage stall function.

Function Code	Name	Setting Range
Pb.08	Auto current limiting threshold	50-200% 【 G Model: 160% P Model: 120% 】
Pb.09	Frequency decrease rate when current limiting	0.00~50.00Hz/s 【 10.00Hz/s 】
Pb.10	Action selection when current limiting	0~1 【 0 】

0: Enabled

1: Disabled when constant speed

Auto current limiting is used to limit the current of inverter smaller than the value determined by Pb.08 in real time. Therefore the inverter will not trip due to surge over-current. This function is especially useful for the applications with big load inertia or step change of load.

Pb.08 is a percentage of the inverter's rated current.

Pb.09 defines the decrease rate of output frequency when this function is active. If Pb.08 is too small, overload fault may occur. If it is too big, the frequency will change too sharply and therefore, the feedback energy of motor will be too large and may cause over-voltage fault. This function is always enabled during acceleration or deceleration. Whether the function is enabled in constant speed running is determined by Pb.10.

Note:

- During auto current limiting process, the inverter's output frequency may change; therefore, it is recommended not to enable the function when inverter needs to output stable frequency
- During auto current limiting process, if Pb.08 is too low, the overload

capacity will be impacted.

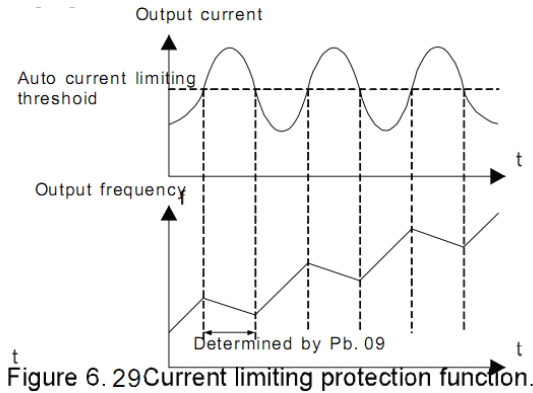

Figure 6.29 Current limiting protection function.

Function Code	Name	Setting Range
Pb.11	Selection of overtorque (OL3)	0-4 【1】
Pb.12	Detection level of overtorque	10.0% ~200.0% 【Depend on the model】

0 : Nodetection

1 : Valid detection of overtorque during running, then continue running

2 : Valid detection of overtorque during running , then warning and stop

3 : Valid detection of overtorque during constant speed running, then continue running

4 : Valid detection of overtorque during constant speed running, then warning (OL3) and stop.

G model: 150%

P model: 120%

This value is depending on model.

Function Code	Name	Setting Range
Pb.13	Detection time of overtorque	0.0~60.0s 【0.1s】

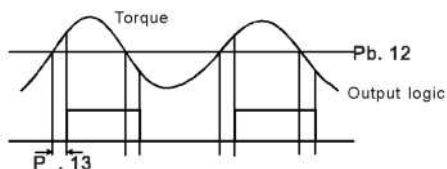

Figure 6.30 Overtorque control function.

If Pb.11 is set to be 1 or 3, and if the output torque of inverter reaches to Pb.12, and with delay of Pb.13, this will output the overtorque. And the TRIP light will reflash. If P6.01 ~P6.03 are set to be 10, the output will be valid.

If Pb.11 is set to be 2 or 4, when overtorque signal meets the output conditions, inverter performs warning signal OL3, and meanwhile stops the output.

PC Group Serial Communication

Function Code	Name	Setting Range
PC.00	Local address	0-247 【1】

When the master is writing the frame, the communication address of the slave is set to 0, the address is the communication address. All slaves on the MODBUS fieldbus can receive the frame, but the slave doesn't answer.

The communication of the drive is unique in the communication net. This is the fundamental for the point to point communication between the upper monitor and the drive.

Note : The address of the slave cannot set to 0.

This parameter determines the slave address used for communication with master. The value "0" is the broadcast address.

Function Code	Name	Setting Range
PC.01	Baud rate selection	0-5 【4】

0:1200BPS

1:2400BPS

2: 4800BPS

3: 9600BPS

4:19200BPS

5: 38400BPS

This parameter can set the data transmission rate during serial communication.

The baud rate between the upper monitor and the inverter must be the same. Otherwise, the communication is not applied. The bigger the baud rate, the quicker the communication speed.

Function Code	Name	Setting Range
PC.02	Data format	0-5 【0】

0: RTU, 1 start bit, 8 data bits, no parity check, 1 stop bit.

1: RTU, 1 start bit, 8 data bits , even parity check, 1 stop bit.

2: RTU, 1 start bit, 8 data bits, odd parity check, 1 stop bit.

3: RTU, 1 start bit, 8 data bits, no parity check, 2 stop bits.

4: RTU, 1 start bit, 8 data bits, even parity check, 2 stop bits.

5: RTU, 1 start bit, 8 data bits, odd parity check, 2 stop bits.

This parameter defines the data format used in serial communication protocol

Function Code	Name	Setting Range
PC.03	Communication delay time	0 ~ 200ms 【5ms】

This parameter means the interval time when the drive receive the data and sent it to the upper monitor. If the answer delay is shorter than the system processing time, then the answer delay time is the system processing time, if the answer delay is longer than the system processing time ,then after the system deal with the data, waits until achieving the answer delay time to send the data to the upper monitor.

Function Code	Name	Setting Range
PC.04	Communication timeout delay	0.0-100.0s 【0.0s】

When the function code is set as 0.0, the communication overtime parameter is invalid. When the function code is set to a valid value, if the interval time between two communications exceeds the communication overtime, the system will report “communication faults” (CE).

Generally, set it as invalid; set the parameter in the continuous communication to monitor the communication state.

Function Code	Name	Setting Range
PC.05	Communication error action	0-3 【1】

0: When communication error occurs, inverter will alarm (CE) and coast to stop.

1: When communication error occurs, inverter will omit the error and continue to run.

2: When communication error occurs, if P0.01=2, inverter will not alarm but stop according to stop mode determined by P1.06. Otherwise it will omit the error.

3: When communication error occurs, inverter will not alarm but stop according

to stop mode determined by P1.06.

Function Code	Name	Setting Range
PC.06	Response action	00-11 【0000】

Unit's place of LED

0: Response to writing

1: No response to writing Ten's place of LED

0: Reference not saved when power off

1: Reference saved when power off

PD Group Supplementary Function

Function Code	Name	Setting Range
Pd.00-Pd.09	Reserved	

PE Group Factory Setting

This group is the factory-set parameter group. It is prohibited for user to modify.

7. TROUBLE SHOOTING

This chapter tells how to reset faults and view fault history. It also lists all alarm and fault messages including the possible cause and corrective actions.

7.1 Fault and Trouble shooting

Fault Code	Fault Type	Reason	Solution
OUT1	IGBT Ph-U fault	<ol style="list-style-type: none"> 1. Acc time is too short. 2. IGBT module fault. 3. Malfunction caused by interference. 4. Grounding is not properly. 	<ol style="list-style-type: none"> 1. Increase Acc time. 2. Ask for support. 3. Inspect external equipment and eliminate interference.
OUT2	IGBT Ph-V fault		
OUT3	IGBT Ph-W fault		
OC1	Over-current when acceleration	<ol style="list-style-type: none"> 1. Acc time is too short. 2. The voltage of the grid is too low. 3. The power of the inverter is too low. 	<ol style="list-style-type: none"> 1. Increase Acc time. 2. Check the input power 3. Select bigger capacity inverter.
OC2	Over-current when deceleration	<ol style="list-style-type: none"> 1. Dec time is too short. 2. The torque of the load inertia is big. 3. The power of the inverter is too low. 	<ol style="list-style-type: none"> 1. Increase Dec time. 2. Install a proper energy consumption braking components 3. Select bigger capacity inverter.
OC3	Over-current when constant speed running	<ol style="list-style-type: none"> 1. The load transients or is abnormal. 2. The voltage of the grid is too low. 3. The power of the inverter is too low. 	<ol style="list-style-type: none"> 1. Check the load or reduce the transient of the load 2. Check the input power supply 3. Select bigger capacity inverter.
OV1	Over-voltage when acceleration	<ol style="list-style-type: none"> 1. The input voltage is abnormal 2. Restart the running motor after sudden power loss. 	<ol style="list-style-type: none"> 1. Check the input power 2. Avoid re start-up after stopping

Fault Code	Fault Type	Reason	Solution
OV2	Over-voltage when deceleration	<ol style="list-style-type: none"> 1. Dec time is too short. 2. The inertia of the load is big. 3. The input voltage is abnormal 	<ol style="list-style-type: none"> 1. Increase the Dec time 2. Increase the energy-consuming components 3. Check the input power
OV3	Over-voltage when constant speed running	<ol style="list-style-type: none"> 1. The input voltage changes abnormally. 2. The inertia of the load is big. 	<ol style="list-style-type: none"> 1. Install the input reactor 2. Add proper energy-consuming components
UV	DC bus Under-voltage	<ol style="list-style-type: none"> 1. The voltage of the grid is low 	<ol style="list-style-type: none"> 1. Check the input power supply of the grid
OL1	Motor overload	<ol style="list-style-type: none"> 1. The voltage of the power supply is too low. 2. The motor setting rated current is incorrect. 3. The motor stall or load transients is too strong. 4. The power of the motor is too big. 	<ol style="list-style-type: none"> 1. Check the power of the supply line 2. Reset the rated current of the motor 3. Check the load and adjust the torque lift 4. Select a proper motor.
OL2	Inverter overload	<ol style="list-style-type: none"> 1. The acceleration is too fast 2. Reset the rotating motor 3. The voltage of the power supply is too low. 4. The load is too heavy. 	<ol style="list-style-type: none"> 1. Increase the ACC time 2. Avoid the restarting after stopping. 3. Check the power of the supply line 4. Select an inverter with bigger power
SPI	Input phase loss	Phase loss or fluctuation of input R, S and T	<ol style="list-style-type: none"> 1. Check input power 2. Check installation distribution
SPO	Output phase loss	U, V and W phase loss input (or serious)	<ol style="list-style-type: none"> 1. Check the output distribution

Fault Code	Fault Type	Reason	Solution
		asymmetrical three phase of the load)	2. Check the motor and cable
OH1	Rectify overheat	1 .Sudden overcurrent of the inverter 2. There is direct or indirect short circuit between output 3 phase	1. Refer to the overcurrent solution
OH2	IGBT overheat	3. Air duct jam or fan damage 4-Ambient temperature is too high. 5. The wiring of the control panel or plug-ins are loose 6. The assistant power supply is damaged and the drive voltage is undervoltage 7. The bridge arm of the power module is switched on 8. The control panel is abnormal	2. Redistribute 3. Dredge the wind channel or change the fan 4. Low the ambient temperature 5. Check and reconnect 6. Ask for service 7. Ask for service 8. Ask for service
EF	External fault	S1: External fault input terminal take effect.	1. Check the external device input
CE	Communication fault	1. The baud rate setting is incorrect. 2. Communication fault 3.The communication is off for a long time.	1. Set proper baud rate 2. Press STOP/RST to reset and ask for help 3. Check the communication connection distribution
IE	Current detection fault	1. The connection of the control board is not good	1. Check and reconnect 2. Ask for service

Fault Code	Fault Type	Reason	Solution
		<p>Assistant power is bad</p> <p>2.Assistant power is damaged</p> <p>3.Hoare components is broken</p> <p>4.The modifying circuit is abnormal.</p>	<p>3. Ask for service</p> <p>4. Ask for service</p>
tE	Autotuning fault	<p>1. The motor capacity does not comply with the inverter capability</p> <p>2. The rated parameter of the motor does not set correctly.</p> <p>3. The offset between the parameters from autotune and the standard parameter is huge</p> <p>4. Autotune overtime</p>	<p>1.Change the inverter model 2.Set the rating parameters according to the nameplate of the motor</p> <p>3.Empty the motor and identify again</p> <p>4. Check the motor wiring and set the parameters</p>
EEP	EEPROM fault	<p>1. Error of controlling the write and read of the parameters</p> <p>2. Damage to EEPROM</p>	<p>1. Press [STOP/RST] to reset</p> <p>2. Ask for service</p>
PIDE	PID feedback fault	<p>1. PID feedback offline</p> <p>2. PID feedback source disappear</p>	<p>1. Check the PID feedback signal wires</p> <p>2. Check PID feedback source</p>
bCE	Braking unit fault	<p>1. Braking circuit fault or damage to the braking pipes</p> <p>2. The external braking resistor is a little low</p>	<p>1. Check the braking unit and change new braking pipes</p> <p>2. Increase the braking resistor</p>

Fault Code	Fault Type	Reason	Solution
END	Time reach of factory setting	1. Trial time arrival	1. Ask for service
OL3	Overtorque	<ol style="list-style-type: none"> 1. The acceleration is too fast 2. Reset the rotating motor 3. The voltage of the power supply is too low. 4. The load is too heavy. 	<ol style="list-style-type: none"> 1. Increase the ACC time 2. Avoid the restarting after stopping. 3. Check the power of the supply line 4. Select an inverter with bigger power 5. Adjust Pb.11 to a proper value

7.2 Common Faults and Solutions

Inverter may have following faults or malfunctions during operation, please refer to the following solutions.

No display after power on:

- Inspect whether the voltage of power supply is the same as the inverter rated voltage or not with multi-meter. If the power supply has problem, inspect and solve it.
- Inspect whether the three-phase rectify bridge is in good condition or not. If the rectification bridge is burst out, ask for support.
- Check the CHARGE light. If the light is off, the fault is mainly in the rectify bridge or the buffer resistor. If the light is on, the fault may be lies in the switching power supply. Please ask for support.

Power supply air switch trips off when power on:

- Inspect whether the input power supply is grounded or short circuit. Please solve the problem.
- Inspect whether the rectify bridge has been burnt or not. If it is damaged, ask for support.

Motor doesn't move after inverter running:

- Inspect if there is balanced three-phase output among U, V, and W. If yes, then motor could be damaged, or mechanically locked. Please solve it.
- Ask for help if the output is unbalanced,
- Ask for help if there is no output voltage.

Inverter displays normally when power on, but switch at the input side trips when running:

- Inspect whether the output side of inverter is short circuit. If yes, ask for support.
- Inspect whether ground fault exists. If yes, solve it.
- If trip happens occasionally and the distance between motor and inverter is too far, it is recommended to install output AC reactor.

8. MAINTENANCE



WARNING

- Maintenance must be performed according to designated maintenance methods.
- Maintenance, inspection and replacement of parts must be performed only by certified person.
- After turning off the main circuit power supply, wait for 10 minutes before maintenance or inspection.
- DO NOT directly touch components or devices of PCB board. Otherwise inverter can be damaged by electrostatic.
- After maintenance, all screws must be tightened.

8.1 Daily Maintenance

In order to prevent the fault of inverter to make it operate smoothly in high-performance for a long time, user must inspect the inverter periodically (within half year). The following

table indicates the inspection content.

Checking item	Content
Temperature/H umidity	Ensure the temperature is among 0°C~40°C, and the humidity is among 20~90%
Oil fog and dust	Ensure that there is no oil fog, dust and condensation in the inverter.
The inverter	Enaure there is no abnormal heating, and abnormal vibration to the inverter.
The fan	Ensure the fan rotates normally and there is no foreign objection in the inverter.
Input power supply	Ensure the voltage and frequency of the power supply is in the allowed range.
The motor	Ensure there is no abnormal vibration, heating noise and phase loss.

table indicates the inspection content.

Checking item	Content
Temperature/H umidity	Ensure the temperature is among 0°C~40°C, and the humidity is among 20~90%
Oil fog and dust	Ensure that there is no oil fog, dust and condensation in the inverter.
The inverter	Enaure there is no abnormal heating, and abnormal vibration to the inverter.
The fan	Ensure the fan rotates normally and there is no foreign objection in the inverter.
Input power supply	Ensure the voltage and frequency of the power supply is in the allowed range.
The motor	Ensure there is no abnormal vibration, heating noise and phase loss.

8.2 Periodic Maintenance

Customer should check the inverter every 6 months according to the actual environment.

Checking item	Content	Method
Screws of the external terminals	Check if the screw is loose or not.	Tjghten up
PCB board	Dust and dirtness	Clear the sundries with dry compressed air.
The fan	Check if the accumulative time of abnormal noise and vibration exceeds 20,000 hours.	1. clear the sundries 2. change the fan

Electrolytic capacitance	Check if the color has changed and if it smelly	Change the electrolytic capacitance.
Heat sink	Dust and dirtiness	Clear the sundries with dry compressed air.
Power components	Dust and dirtiness	Clear the sundries with dry compressed air.

8.3 Replacement of wearing parts

Fans and electrolytic capacitors are wearing parts; please make periodic replacement to ensure long term , safety and failure-free operation. The replacement periods are as follows:

- ◆ Fan: Must be replaced when using up to 20,000 hours;
- ◆ Electrolytic Capacitor: Must be replaced when using up to 30 · 000~40 · 000 hours.

9. COMMUNICATION PROTOCOL

9.1 Interfaces

RS485: asynchronous · half-duplex.

Default: 8-E-1, 19200bps. See Group PC parameter settings.

9.2 Communication Modes

9.2.1 The protocol is Modbus protocol. Besides the common register Read/Write operation, it is supplemented with commands of parameters management.

9.2.2 The drive is a slave in the network. It communicates in 'point to point · master-slave mode. It will not respond to the command sent by the master via broadcast address.

9.2.3 In the case of multi-drive communication or long-distance transmission, connecting a 100 ~ 120Q resistor in parallel with the master signal line will help to enhance the immunity to interference.

9.3 Protocol Format

Modbus protocol supports both RTU. The frame format is illustrated as follows:

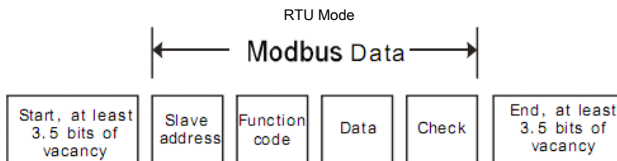

Modbus adopts “Big Endian” representation for data frame. This means that when a numerical

quantity larger than a byte is transmitted, the most significant byte is sent first.

RTU mode

In RTU mode, the Modbus minimum idle time between frames should be no less than 3.5 bytes.

The checksum adopts CRC-16 method. All data except checksum itself sent will be counted into the calculation. Please refer to section: CRC Check for more information. Note that at least 3.5 bytes of Modbus idle time should be kept and the start and end idle time need not be summed up to it.

The table below shows the data frame of reading parameter 002 from slave node address 1.

Node addr.	Command	Data addr.		Read No.		CRC	
0x01	0x03	0x00	0x02	0x00	0x01	0x25	0xCA

The table below shows the reply frame from slave node address 1

Node addr.	Command	Bytes No.	Data		CRC	
0x01	0x03	0x02	0x00	0x00	0xB8	0x44

9.4 Protocol function

Different respond delay can be set through drive's parameters to adapt to different needs. For RTU mode, the respond delay should be no less than 3.5 bytes interval.

The main function of Modbus is to read and write parameters. The Modbus protocol supports the following commands:—

0x03	Read inverter's function parameter and status parameters
0x06	Write single function parameter or command parameter to inverter

All drive's function parameters, control and status parameters are mapped to Modbus R/Wdata address.

The data address of control and status parameters please refer to the following table.

Parameter Description	Address	Meaning of value	R/W Feature
Control command	1000H	0001H: Forward	W/R
		0002H: Reverse	
		0003H: JOG forward	
		0004H: JOG reverse	
		0005H: Stop	
		0006H: Coast to stop	
		0007H: Reset fault	
		0008H: JOG stop	
Inverter status	1001H	0001H: Forward running	R
		0002H: Reverse running	
		0003H: Standby	
		0004H: Fault	
		0005H: Status of inverter POF	
Communication setting	2000H	<p>Communication Setting Range (-10000-10000) Note: the communication setting is the percentage of the relative value (-100.00%~ 100.00%). If it is set as frequency source , the value is the</p>	W/R

Parameter Description	Address	Meaning of value	R/W Feature
		percentage of the maximum frequency. If it is set as PID (preset value or feedback value), the value is the percentage of the PID.	
	2001 H	PID setting, Range: 0~ 1000 , 1000 means100.0%	W/R
	2002 H	PID feedback, Range: 0~ 1000 , 1000 means"100.0%	W/R
	2003H	Setting value of torque Range: -1000~1000 , 1000 means 100.0%	W/R
	2004H	Setting value of upper limit frequency (<0~Fmax)	W/R
Status parameters	3000H	Output frequency	R
	3001H	Reference frequency	R
	3002H	DC Bus voltage	R
	3003H	Output voltage	R
	3004H	Output current	R
	3005H	Rotation speed	R
	3006H	Output power	R
	3007H	Output torque	R
	3008H	PID preset value	R
	3009H	PID feedback value	R
	300AH	Input terminal status	R
	300BH	Output terminal status.	R
	300CH	Input of AI1	R
	300DH	Input of AI2	R
	300EH	Reserved	R
	300FH	Reserved	R
3010H	HDI frequency	R	
3011H	Reserved	R	

Parameter Description	Address	Meaning of value	R/W Feature
	3012H	Step No. of PLC or multi-step	R
	3013H	Reserved	R
	3014H	External counter input	R
	3015H	Torque setting	R
	3016H	Device code	R
Inveter fault info address	5000H	0X00H: No fault 0X01H: OUT1 0X02H: UT2 0X03H: OUT3 0X04H: OC1 0X05H: OC2 0X06H: OC3 0X07H: OV1 0X08H: OV2 0X09H: OV3 0x0A: UV 0x0B: OL1 0x0C:OL2 0x0D: SPI 0x0E: SPO 0x0F: OH1 0x10: OH2 0x11: EF 0x12: CE 0x13: ItE 0x14: tE 0x15: EEP 0x16:PIDE 0x17: bCE 0x18: END 0x19: OL3	R

The above shows the format of the frame. Now we will introduce the Modbus command and data structure in details, which is called protocol data unit for simplicity. Also MSB stands for the most significant byte and LSB stands for the least significant byte for the same reason. The description below is data format in RTU mode.

Protocol data unit format of reading parameters:

Request format:

Protocol data unit	Data length(bytes)	Range
Command	1	0x03
Data Address	2	0~0xFFFF
Read number	2	0x0001 ~ 0x0010

Reply format (success):

Protocol data unit	Data length(bytes)	Range
Command	1	0x03
Returned byte number	2	2* Read number
Content	2* Read number	

If the command is reading the type of inverter (data address 0x3016) ,the content value in reply message is the device code:

The high 8 bit of device code is the type of the inverter, and the low 8 bit of device code is the sub type of inverter.

For details, please refer to the following table:

High byte	Meaning	Low byte	Meaning
00	CHV	01	Vector control type
		02	For water supply
		03	Middle frequency 1500Hz
		04	Middle frequency 3000Hz
01	CHE	01	Vector control type
		02	Middle frequency 1500Hz
02	CHF	01	Universal type
		02	Vector type THE

If the operation fails, the inverter will reply a message formed by failure command and error code. The failure command is (Command+0x80). The error code indicates the reason of the error; see the table below.

Value	Name	Mean
01H	Illegal command	The command from master can not be executed. The reason maybe: 1 This command is only for new version and this version can not realize. 2 Slave is in fault status and can not execute it.
02H	Illegal data address.	Some of the operation addresses are invalid or not allowed to access.
03H	Illegal value	When there are invalid data in the message framed received by slave. Note: This error code does not indicate the data value to write exceed the range, but indicate the message frame is a illegal frame.
06H	Slave busy	Inverter is busy(EEPROM is storing)
10H	Password error	The password written to the password check address is not same as the password set by P7.00.
11H	Check error	The CRC (RTU mode) check not passed.
12H	Written not allowed.	It only happen in write command, the reason maybe: 1 The data to write exceed the range of according parameter 2 The parameter should not be modified now. 3 The terminal has already been used.
13H	System locked	When password protection take effect and user does not unlock it, write/read the function parameter will return this error.

Protocol data unit format of writing single parameter:

Request format:

Protocol data unit	Data length (bytes)	Range
Command	1	0x06
Data Address	2	0~0xFFFF
Write Content	2	0~0xFFFF

Reply format (success):

Protocol data unit	Data length (bytes)	Range
Command	1	0x06
Data Address	2	0~0xFFFF
Write Content	2	0~0xFFFF

If the operation fails, the inverter will reply a message formed by failure command and error code. The failure command is (Command+0x80). The error code indicates the reason of the error; see table 1.

9.5 Note:

9.5.1 Between frames, the span should not less than 3.5 bytes interval, otherwise, the message will be discarded.

9.5.2 Be cautious to modify the parameters of PC group through communication, otherwise may cause the communication interrupted.

9.5.3 In the same frame, if the span between two near bytes more than 1.5 bytes interval, the behind bytes will be assumed as the start of next message so that communication will failure.

9.6 CRC Check

For higher speed, CRC-16 uses tables. The following are C language source code for CRC-16.

```
unsigned int crc_cal_value(unsigned char *data_value,unsigned char data_length)
{
    inti;
    unsigned int crc_value=0xffff; while (data_length-)
    {
        crc_value^=*data_value++;
        for(i=0;i<8;i++)
        {
            if(crc_value&0x0001)crc_value=(crc_value>>1)^0xa001;
            else crc_value=crc_value>>1;
        }
    }
    return(crc_value);
}
```

9.7 Example

9.7.1 Command code : 03H(0000 0011), read N words (Word) {the continuous Max. reading is 16 words)

For example, read continuous 2 words from the inverter with the address of 01H. The frame structure is as below:

RTU master command message (from the master to the inverter)

START	T1-T2-T3-T4
ADDR	01H
CMD	03H
High bit of the start bit	00H
Low bit of the start bit	03H
High bit of data number	00H
Low bit of data number	02 H
CRC low bit	34H
CRC high bit	0BH
END	T1-T2-T3-T4

RTU slave response message

START	T1-T2-T3-T4
ADDR	01H
CMD	03H
Byte [] umber	04H
Data high bit of address 0004H	13H
Data low bit of address 0004H	88H
Data high bit of address 0005H	13H
Data low bit of address 0005H	88H
CRC CHKlowbit	73H
CRC CHKhigh bit	CBH
END	T1-T2-T3-T4

9.7.2 Command code : 06H
06H (0000 0110) , write one word{Word)

For example, write 5000 (1388H) to 0006H from the inverter with the address of 02H, the frame structure is as below:

RTU master command message

START	T1-T2-T3-T4
ADDR	02H
CMD	06H
High bit of writing data address	00H
Low bit of writing data address	06H
Data content	13H
Data content	88H
CRC CHKlowbit	64H
CRC CHKhigh bit	AEH
END	T1-T2-T3-T4

RTU slave response message

START	T1-T2-T3-T4
ADDR	02 H
CMD	06H
High bit of writing data address	00H
Low bit of writing data address	06H
High bit of data content	13H
Low bit of data content	88H
CRC CHKlowbit	64H
CRC CHKhigh bit	AEH
END	T1-T2-T3-T4

9.7.3 Command code 08H (0000 1000) for diagnosis Meaning of sub-function codes:

Sub-function Code	Description
0000	Return to inquire information data

For example: The inquiry information string is same as the response information string when the loop detection to address 01H of driver is carried out.

The RTU request command is:

START	T1-T2-T3-T4
ADDR	01H
CMD	0SH
High byte of sub-function code	00H
Low byte of sub-function code	00H
High byte of data content	12H
Low byte of data content	ABH
Low byte of CRC	ADH
High byte of CRC	14H
END	T1-T2-T3-T4

The RTU response command is:

START	T1-T2-T3-T4
ADDR	01H
CMD	08H
High byte of sub-function code	00H
Low byte of sub-function code	00H
High byte of data content	12H
Low byte of data content	ABH
Low byte of CRC	ADH
High byte of CRC	14H
END	T1-T2-T3-T4

Appredix A: LIST OF FUNCTION PARAMETERS

The function parameters of the series inverters have been divided into 16 groups (POPE) according to the function. Each function group contains certain function codes applying 3-class menus. For example, "P8.08" means the eighth function code in the P8 group function, PE group is factory reserved, and users are forbidden to access these parameters.

For the convenience of function codes setting, the function group number corresponds to the first class menu, the function code corresponds to the second class menu and the function code corresponds to the third class menu.

1. Below is the instruction of the function lists:

The first line "Function code" : codes of function parameter group and parameters :

The second line "Name" : full name of function parameters!

The third line "Detailed illustration of parameters" : Detailed illustration of the function parameters

The forth line "Setting range" : the effective setting range of the function parameters which will displayed on the LCD :

The fifth line "Factory Setting" : the original factory set value of the function parameter : The sixth line "Modify" : the modifying character of function codes (the parameters can be modified or not and the modifying conditions), below is the instruction :

"○" : means the set value of the parameter can be modified on stop and running state :

"⊙" : means the set value of the parameter can not be modified on the running state :

"●" : means the value of the parameter is the real detection value which can not be modified.

(The inverter has limited the automatic inspection of the modifying character of the parameters to help users avoid mismodifying)

The seventh line "No.": The serial number of function code, at the same time, it also means the register address during communication.

2. "Parameter radix" is decimal (DEC), if the parameter is expressed by hex, then the parameter is separated from each other when editing. The setting range of certain bits are 0~F (hex).

3. "Factory setting" means the function parameter will restore to the default value during default parameters restoring. But the detected parameter or recorded value won't be restored.

4. For a better parameter protection, the inverter provides password protection to the parameters. After setting the password (set P7.00 to any non-zero number), the system will come into the state of password verification firstly after the user press |PRG/ESC| to come into the function code editing state. And then "0.0.0.0.0." will be displayed. Unless the user input right password, they cannot enter into the system. For the factory setting parameter zone, it needs correct factory password (remind that the users can not modify the factory parameters by themselves, otherwise, if the parameter setting is incorrect, damage to the inverter may occur). If the password protection is unlocked, the user can modify the password freely and the inverter will work as the last setting one. When P7.00 is set to 0, the password can be canceled. If P7.00 is not 0 during powering on, then the parameter is protected by the password. When modify the parameters by serial communication, the function of the password follows the above rules, too.

Function Code	Name	Description	Setting Range	Factory Setting	Modify	No.
PO Group: Basic Function						
P0.00	Speed Control model	0: V/F control 1: Sensorless vector control 2: Torque control (sensorless vector control)	0-2	0	⊙	0.
P0.01	Run command source	0: Keypad (LED extinguished) 1: Terminal (LED flickering) 2: Communication (LED lights on)	0-2	0	⊙	1.
P0.02	Keypad and terminal UP/DOWN setting	0: Valid, save UP/DOWN value when power off 1: Valid, do not save UP/DOWN value when power off 2: Invalid 3: Valid during running, clear when stop.	0-3	0	○	2.
P0.03	Maximum frequency	10.00-400.00Hz	10.00-400.00	50.00Hz	⊙	3.
P0.04	Upper frequency limit	P0.05~P0.03(the Maximum frequency)	P0.05-P0.03	50.00Hz	○	4.
P0.05	Lower frequency limit	0.00~P0.04(Lower frequency limit)	0.00-P0.04	0.00Hz	○	5.
P0.06	Keypad reference frequency	0.00 ~ P0.03(the Maximum frequency)	0.00-P0.03	50.00Hz	○	6.
P0.07	Frequency A command source	0: Keypad 1: AI1 2: AI2 3: HDI.4: Simple PLC 5: Multi-stage speed 6: PID 7: Remote communication	0-7	0	○	7.

Function Code	Name	Description	Setting Range	Factory Setting	Modify	No.
P0.08	Frequency B command source	0:A1 1:A2 2:HDI	0-2	0	○	8.
P0.09	Scale of frequency B command	0: Maximum frequency 1: Frequency A command	0~1	0	○	9.
P0.10	Frequency command selection	0: A 1: B 2: A+B 3: Max (A and B)	0-3	0	○	10.
P0.11	Acceleration time 0	0.1-3600.0s	0.1 ~ 3600.0	Depend On model	○	11.
P0.12	Deceleration time 0	0.1 ~ 3600.0s	0.1-3600.0	Depend On model	○	12.
P0.13	Running direction selection	0: Forward 1: Reverse 2: Forbid reverse	0-2	0	◎	13.
P0.14	Carrier frequency	1.0 ~ 15.0kHz	1.0-15.0	Depend On model	○	14.
P0.15	AVR function	0 : Invalid 1 : Valid all the time 2 : Only valid in deceleration	0-2	1	○	15.
P0.16	Motor parameters autotuning	0: No action 1: Rotation autotuning 2: Static autotuning	0-2	0	◎	16.
P0.17	Restore parameters	0: No action 1: Restore factory setting 2: Clear fault records	0-2	0	◎	17.

Function Code	Name	Description	Setting Range	Factory Setting	Modify	No.
P1 Group: Start and Stop Control						
P1.00	Start Mode	0: Start directly 1: DC braking and start 2: Speed tracking and start	0-2	0	⊙	18.
P1.01	Starting frequency	0.00-10.00Hz	0.00-10.00	1.50Hz	⊙	19.
P1.02	Hold time of starting frequency	0.0~50.0s	0.0-50.0	0.0s	⊙	20.
P1.03	DC Braking current before start	0.0~150.0%	0.0 ~150.0	0.0%	⊙	21.
P1.04	DC Braking time before start	0.0-50.0s	0.0-50.0	0.0s	⊙	22.
P1.05	Acceleration / Deceleration mode	0: Linear 1: reserved	0~1	0	⊙	23.
P1.06	Stop mode	0: Decelerate to stop 1: Coast to stop	0~1	0	○	24.
P1.07	Starting frequency of DC braking	0.00-P0.03	0.00-P0.03	0.00Hz	○	25.
P1.08	Waiting time before DC braking	0.0-50.0s	0.0-50.0	0.0s	○	26.

Function Code	Name	Description	Setting Range	Factory Setting	Modify	No.
P1.09	DC braking current	0.0~150.0%	0.0 ~ 150.0	0.0%	<input type="radio"/>	27.
P1.10	DC braking time	0.0~50.0s	0.0-50.0	0.0s	<input type="radio"/>	28.
P1.11	Dead time of FWD/REV	0.0~3600.0s	0.0-3600.0	0.0s	<input type="radio"/>	29.
P1.12	Action when running	0: Running at the lower frequency limit 1: Stop 2: Stand-by	0-2	0	<input checked="" type="radio"/>	30.
P1.13	Delay time for restart	0.0~3600.0s (valid when P1.12=2)	0.0-3600.0	0	<input checked="" type="radio"/>	31.
P1.14	Restart after power off	0: Disabled 1: Enabled	0~1	0	<input type="radio"/>	32.
P1.15	Waiting time of restart	0.0~3600.0s (valid when P1.14=1)	0.0-3600.0	0.0s	<input type="radio"/>	33.
P1.16	Terminal detection	0: Disabled 1: Enabled	0~1	0	<input type="radio"/>	34.
P1.17	Reserved	Reserved			<input checked="" type="radio"/>	35
P1.18	Reserved	Reserved			<input checked="" type="radio"/>	36
P1.19	Reserved	Reserved			<input checked="" type="radio"/>	37

Function Code	Name	Description	Setting Range	Factory Setting	Modify	No.
P2 Group: Motor Parameters						
P2.00	Inverter model	0: G model 1: P model	0~1	Depend on model	☉	38.
P2.01	Motor rated power	0.4~900.0kW	0.4-3000.0	Depend on model	☉	39.
P2.02	Motor rated frequency	0.01 HZ-P0.03	10.00~P0.0 3	50.00Hz	☉	40.
P2.03	Motor rated speed	0~36000rpm	0-36000	Depend on model	☉	41.
P2.04	Motor rated voltage	0~800V	0-800	Depend on model	☉	42.
P2.05	Motor rated current	0.8-6000.0A	0.8-6000.0	Depend on model	☉	43.
P2.06	Motor stator resistance	0.001~65.535Ω	0.001-65.535	Depend on model	○	44.
P2.07	Motor rotor resistance	0.001-65.535Ω	0.001-65.535	Depend on model	○	45.
P2.08	Motor leakage	0.1-6553.5m H	0.1-6553.5	Depend on model	○	46.
P2.09	Motor mutual inductance;	0.1 ~6553.5m H	0.1 ~6553.5	Depend on model	○	47
P2.10	Current without load	0.01-655.35A	0.1 ~6553.5	Depend on model	○	48

Function Code	Name	Description	Setting Range	Factory Setting	Modify	No.
P3 Group: Vector Control						
P3.00	ASR proportional gain Kp1	0-100	0-100	20	○	49.
P3.01	ASR integral time K.-1	0.01 ~10.00s	0.01-10.00	0.50s	○	50.
P3.02	ASR switching point 1	0.00HZ-P3.05	0.00-P3.05	5.00Hz	○	51.
P3.03	ASR proportional gain Kp2	0-100	0-100	25	○	52.
P3.04	ASR integral time K.-2	0.01 ~10.00s	0.01-10.00	1.00s	○	53.
P3.05	ASR switching point 2	P3.02 ~P0.03(the Maximum frequency)	P3.02-P0.03	10.00Hz	○	54.
P3.06	Slip compensation rate of VC	50.0%~200.0%	50-200	100%	○	55.
P3.07	Torque upper limit	0.0~200.0%(the rated current of the inverter)	0.0-200.0	G model : 150.0% P model:120.0%	○	56.
P3.08	Torque setting source	0: Keypad (corresponds to P3.09) 1:AI1 2:AI2 3:HDI 4:Multi-step speed 5: Remote communication (1 ~5: 100% corresponds to 2 times of the rated current of the inverter)	0-5	0	○	57
P3.09	Keypad torque setting	-200.0%~200.0%(the rated current of the inverter)	-200.0~200.0	50.0%	○	58.
P3.10	Upper frequency setting source	0: Keypad (P0.04) 1: AM 2: AI2 3: HDI 4: Multi-step 5: Remote communication (1 ~4: 100% corresponds to the Max. frequency)	0-5	0	○	59.

Function Code	Name	Description	Setting Range	Factory Setting	Modify	No.
P4 Group: V/F Control						
P4.00	V/F curve selection	0: Linear curve 1: Multidots curve 2: Torque—stepdown curve (1.3 order) 3: Torque—stepdown curve (1.7 order) 4: Torque—stepdown curve (2.0 order)	0-4	0	<input checked="" type="radio"/>	60.
P4.01	Torque boost	0.0%: (auto) 0.1%~10.0%	0.0-10.0	0.0%	<input type="radio"/>	61.
P4.02	Torque boost cut-off	0.0% ~50.0% (motor rated frequency)	0.0-50.0	20.0%	<input checked="" type="radio"/>	62.
P4.03	V/F frequency 1	0.00Hz~P4.05	0.00-P4.05	0.00Hz	<input type="radio"/>	63.
P4.04	V/F voltage 1	0.0%~100.0%(the rated voltage of the motor)	0.0-100.0	00.0%	<input type="radio"/>	64.
P4.05	V/F frequency 2	P4.03-P4.07	P4.03-P4.07	00.00Hz	<input type="radio"/>	65.
P4.06	V/F voltage 2	0.0%~100.0%(the rated voltage of the motor)	0.0-100.0	00.0%	<input type="radio"/>	66.
P4.07	V/F frequency 3	P4.05- P2.02(the rated frequency of the motor)	P4.05-P2.02	00.00Hz	<input type="radio"/>	67.
P4.08	V/F voltage 3	0.0% ~ 100.0%(the rated voltage of the motor)	0.0-100.0	0.0%	<input type="radio"/>	68.
P4.09	Slip compensation limit	0.00-200.0%	0.0-200.0	0.0%	<input type="radio"/>	69.
P4.10	Auto energy saving selection	0: Disabled 1: Enabled	0~1	0	<input checked="" type="radio"/>	70.
P4.11	Low-frequency threshold of restraining oscillation	0-10	0-10	2	<input type="radio"/>	71.
P4.12	High-frequency threshold of restraining oscillation	0-10	0-10	0	<input type="radio"/>	72.
P4.13	Boundary of restraining oscillation	0.0 ~ P3.03	0.00-P0.03	30.00 Hz	<input type="radio"/>	73.

Function Code	Name	Description	Setting Range	Factory Setting	Modify	No.
P5 Group: Input Tenninals						
P5.00	HDI selection	0: High speed pulse input 1: ON-OFF input	0~1	0	⊙	74.
P5.01	S1 Terminal function	0: Invalid 1: Forward 2: Reverse	0-39	1	⊙	75.
P5.02	S2 Terminal function	3: 3-wire control 4: Jog forward 5: Jog reverse 6: Coast to stop	0-39	4	⊙	76.
P5.03	S3 Terminal function	7: Reset fault 8: Pause running 9: External fault input	0-39	7	⊙	77.
P5.04	S4 Terminal function	10: Up command 11: DOWN command 12: Clear UP/DOWN	0-39	0	⊙	78.
P5.05	S5 terminal function	13: Switch between A and B 14: Switch between A and A+B	0-39	0	⊙	79.
P5.06	S6 terminal function	15: Switch between B and A+B 16: Multi-step speed referencel 17: Multi-step speed reference 2	0-39	0	⊙	80.
P5.07	S7 terminal function	18: Multi-step speed reference 3 19: Multi-step speed reference 4 20: Multi-step speed pause	0-39	0	⊙	81.
P5.08	HDI terminal function	21: ACC/DEC time selectionl n time 22: ACC/DEC time selection 2 23: Reset simple PLC when stop 24: Pause simple PLC 25: Pause PID 26: Pause traverse operation 27: Reset traverse operation 28: Reset counter 29: Reset length 30: ACC/DEC ramp hold 31: Counter input 32: UP/DOWN invalid temporarily 33-39: Reserved	0-39	0	⊙	82.

Function Code	Name	Description	Setting Range	Factory Setting	Modify	No.
P5.09	ON-OFF filter times	1-10	1-10	5	<input type="radio"/>	83.
P5.10	Terminal control mode	0: 2-wire control mode 1 1: 2-wire control mode 2 2: 3-wire control mode 1 3: 3-wire control mode 2	0-3	0	<input checked="" type="radio"/>	84.
P5.11	UP/DOWN setting change rate	0.01~50.00Hz/s	0.01-50.00	0.50HZ/S	<input type="radio"/>	85.
P5.12	AM lower limit	0.00V-10.00V	-10.00-10.00	0.00v	<input type="radio"/>	86.
P5.13	AM lower limit corresponding setting	-100.0% ~ 100.0%	-100.0-100.0	0.0%	<input type="radio"/>	87.
P5.14	AM upper limit	0.00 V~ 10.00 V	-10.00-10.00	10.00V	<input type="radio"/>	88.
P5.15	AM upper limit corresponding setting	- 100.0% ~ 100.0%	-100.0~100.0	100.0%	<input type="radio"/>	89.
P5.16	AM filter time constant	0.00s~ 10.00s	0.00-10.00	0.10s	<input type="radio"/>	90.
P5.17	AI2 lower limit	0.00 V~ 10.00 V	0.00-10.00	0.00v	<input type="radio"/>	91.
P5.18	AI2 lower limit corresponding	-100.0%~100.0%	-100.0-100.0	0.0%	<input type="radio"/>	92.
P5.19	AI2 upper limit	0.00 V~ 10.00 V	0.00-10.00	10.00V	<input type="radio"/>	93.

Function Code	Name	Description	Setting Range	Factory Setting	Modify	No.
P5.20	AI2 upper limit corresponding setting	- 100.0%~100.0%	-100.0-100.0	100.0%	○	94.
P5.21	AI2 filter time constant	0.00s~ 10.00s	0.00-10.00	0.10s	○	95.
P5.22	HDI lower limit	0.0 kHz ~50.0kHz	0.00-50.00	0.00kHz	○	96.
P5.23	HDI lower limit corresponding setting	- 100.0% ~100.0%	-100.0~100.0	0.0%	○	97.
P5.24	HDI upper limit	0.0 KHz~50.0KHz	0.00 ~50.00	50.00kHz	○	98.
P5.25	HDI upper limit corresponding setting	-100.0% ~ 100.0%	-100.0-100.0	100.0%	○	99.
P5.26	HDI filter time constant	0.00s~ 10.00s	0.00-10.00	0.10s	○	100.

Function Code	Name	Description	Setting Range	Factory Setting	Modify	No.
P6 Group: Output Terminals						
P6.00	HDO selection	0: High-speed pulse output 1: ON-OFF output	0~1	0	○	101.
P6.01	HDO ON-OFF Output selection	0: No output 1: Running 2: Run forward 3: Run reverse 4: Fault output	0-20	1	○	102.
P6.02	Relay 1 output selection	5: FDT reached 6: Frequency reached 7: Zero speed running 8: Preset count value reached	0-20	4	○	103.
P6.03	Relay 2 output selection	9: Specified count value reached 10: Length reached 11: Simple PLC step completed 12: PLC cycle completed 13: Running time reached 14: Upper frequency limit reached 15: Lower frequency limit reached 16: Ready 17: Auxiliary motor 1 started 18: Auxiliary motor 2 started 19-20: Reserved	0-20	0	○	104.
P6.04	AO1 function selection	0: Running frequency 1: Reference frequency 2: Rotation speed	0-10	0	○	105.
P6.05	AO2 function selection	3: Output current 4: Output voltage 5: Output power 6: Output torque	0-10	0	○	106.
P6.06	HDO function selection	7: AM voltage 8: AI2 voltage/current 9: HDI frequency	0-10	0	○	107.

Function Code	Name	Description	Setting Range	Factory Setting	Modify	No.
P6.07	A01 lower limit	0.0%~100.0%	0.0-100.0	0.0%	○	108.
P6.08	A01 lower limit corresponding output	0.00V-10.00V	0.00-10.00	0.00V	○	109.
P6.09	A01 upper limit	0.0%~100.0%	0.0-100.0	100.0%	○	110.
P6.10	A01 upper limit corresponding output	0.00V ~ 10.00V	0.00-10.00	10.00V	○	111.
P6.11	A02 lower limit	0.0-100.0%	0.0-100.0	0.0%	○	112.
P6.12	A02 lower limit corresponding output	0-10.00V	0.00-10.00	0.00V	○	113.
P6.13	A02 upper limit	0.0 ~100.0%	0.0-100.0	100.0%	○	114.
P6.14	A02 upper limit corresponding output	0.00-10.00V	0.00-10.00	10.00V	○	115.
P6.15	HDO lower limit	0.00% ~100.00%	0.00-100.00	0.00%	○	116.
P6.16	HDO lower limit	0.000-50.000kHz	0.000-50.000	0.00kHz	○	117.
P6.17	HDO upper limit	0.00% ~100.00%	0.000-100.00	100.0%	○	118.
P6.18	HDO upper limit corresponding output	0.0- 50.0kHz	0.000-50.000	50.00kHz	○	119.

Function Code	Name	Description	Setting Range	Factory Setting	Modify	No.
P7 Group: Human and Machine Interface						
P7.00	User password	0-65535	0-65535	0	○	120.
P7.01	Reserve		Reserved	Reserved	○	121.
P7.02	Reserve		Reserved	Reserved	⊙	122.
P7.03	[QUICK/JOG] Function selection	0: Display status switching 1 : Jog 2: FWD/REV switching 3: Clear UP/DOWN setting 4. QUICKset mode	0-4	0	○	123.
P7.04	[STOP/RST] function selection	0: Valid when keypad control (P0.03=0) 1: Valid when keypad or terminal control (P0.03=0 or 1) 2: Valid when keypad or communication control (P0.03=0 or 2) 3: Always valid	0-3	0	○	124.
P7.05	Keypad display selection	0: Preferential to external keypad 1: Both display, only external key valid. 2: Both display, only local key valid. 3: Both display and key valid.	0-3	0	○	125.
P7.06	Running status display selection 1	0-0XFFFF BIT0: running frequency BIT1: Reference frequency BIT2: DC bus voltage BIT3: Output voltage BIT4: Output current	0~0XFFFF	0X07FF	○	126.

Function Code	Name	Description	Setting Range	Factory Setting	Modify	No.
		BIT5: Rotation speed BIT6: Line speed BIT7: Output power BIT8: Output torque BIT9: PID preset BIT10: PID feedback BIT11: Input terminal status BIT12: Output terminal status BIT13: Torque setting value BIT14: Count value BIT15: Step No. of PLC or multi-step				
P7.07	Running status display selection 2	O-0XFFFF BIT0: AM BIT1: AI2 BIT2: HDI frequency BIT3: Load percentage of motor BIT4: Load percentage of inverter BIT5~15: Reserved	O-0XFFFF	0	○	127.
P7.08	Stop status display selection	O-0XFFFF BIT0: Reference frequency BIT1: DC bus voltage BIT2: Input terminal status BIT3: Output terminal status BIT4: PID preset BIT5: PID feedback BIT6: AM BIT7: AI2 BIT8: HDI frequency BIT9: Step No. of PLC or multi-step BIT10: Torque setting value BIT11- BIT15: Reserved	O-0XFFFF	0x00FF	○	128.

Function Code	Name	Description	Setting Range	Factory Setting	Modify	No.
P7.09	Coefficient of rotation speed	0.1-999.9% Actual mechanical speed = 120 * output frequency * P7.09 / Number of poles of motor	0.1-999.9	100.0%	○	129.
P7.10	Coefficient of line speed	0.1 ~999.9% Line speed = actual mechanical speed * P7.10	0.1-999.9	1.0%	○	130.
P7.11	Rectify module temperature	0~100.0°C			●	131.
P7.12	IGBT module temperature	0~100.0°C			●	132.
P7.13	Software version				●	133.
P7.14	Inverter rated power	0.4~3000.0kW	0.4-3000.0	Depend On model	●	134.
P7.15	Inverter rated current	0.0 ~6000.0A	0.0-6000.0	Depend On model	●	135.
P7.16	Accumulated running time	0~65535h			●	136.

Function	Name	Description	Setting Range	Factory Setting	Modify	No.
P7.17	Third latest fault type	0: Not fault 1: IGBT Ph-U fault(OUT1) 2: IGBT Ph-V fault(OUT2)			•	137.
P7.18	Second latest fault type	3: IGBT Ph-W fault(OUT3) 4: Over-current when acceleration(OC1) 5: Over-current when deceleration(OC2) 6: Over-current when constant speed running(OC3) 7: Over-voltage when acceleration(OVI) 8: Over-voltage when decele ratio n(OV2) 9: Over-voltage when constant speed running(OV3) 10: DC bus Under-voltage(UV)			•	138.
P7.19	Latest fault type	11: Motor overload(OL1) 12: Inverter overload(OL2) 13: Input phase failure(SPI) 14: Output phase failure(SPO) 15: Rectify overheat(OH1) 16: IGBT overheat(OH2) 17: External fault(EF) 18: Communication fault(CE) 19: Current detection fault(ITE) 20: Autotuning fault(TE) 21: EEPROM fault(EEP) 22: PID feedback fault(PIDE) 23: Braking unit fault(BCE) 24: Running time arrival(END) 25: Overtorque fault(OL3)			•	139.

Function Code	Name	Description	Setting Range	Factory Setting	Modify	No.
P7.20	Output frequency at current fault				•	140.
P7.21	Output current at current fault				•	141.
P7.22	DC bus voltage at current fault				•	142.
P7.23	Input terminal status at current fault				•	143.
P7.24	Output terminal status at current fault				•	144.

Function Code	Name	Description	Setting Range	Factory Setting	Modify	No.
P8 Group: Enhanced Function						
P8.00	Acceleration time 1	0.1-3600.0s	0.1~3600.0	Depend On model	<input type="radio"/>	145.
P8.01	Deceleration time 1	0.1-3600.0s	0.1~3600.0	Depend On model	<input type="radio"/>	146.
P8.02	Acceleration time 2	0.1 ~3600.0s	0.1~3600.0	Depend On model	<input type="radio"/>	147.
P8.03	Deceleration time 2	0.1 ~3600.0s	0.1~3600.0	Depend On model	<input type="radio"/>	148.
P8.04	Acceleration time 3	0.1-3600.0s	0.1~3600.0	Depend On model	<input type="radio"/>	149.
P8.05	Deceleration time 3	0.1 ~3600.0s	0.1 ~3600.0	Depend On model	<input type="radio"/>	150.
P8.06	Jog reference	0.00-P0.03	0.00-P0.03	5.00Hz	<input type="radio"/>	151.
P8.07	Jog acceleration time	0.1-3600.0s	0.1-3600.0	Depend On model	<input type="radio"/>	152.
P8.08	Jog deceleration time	0.1-3600.0s	0.1 ~3600.0	Depend On model	<input type="radio"/>	153.
P8.09	Skip Frequency 1	0.00-P0.03	0.00-P0.03	0.00Hz	<input type="radio"/>	154.
P8.10	Skip Frequency 2	0.00~P0.03	0.00~P0.03	0.00Hz	<input type="radio"/>	155.
P8.11	Skip frequency bandwidth	0.00 ~P0.03	0.00-P0.03	0.00Hz	<input type="radio"/>	156.
P8.12	Traverse amplitude	0.0-100.0%	0.0-100.0	0.0%	<input type="radio"/>	157.
P8.13	Jitter frequency	0.0-50.0%	0.0-50.0	0.0%	<input type="radio"/>	158.
P8.14	Rise time of traverse	0.1 ~3600.0s	0.1 ~3600.0	5.0s	<input type="radio"/>	159.
P8.15	Fall time of traverse	0.1-3600.0s	0.1-3600.0	5.0s	<input type="radio"/>	160.
P8.16	Auto reset times	0-3	0-3	0	<input type="radio"/>	161.
P8.17	Reset interval	0.1-100.0s	0.1-100.0	1.0s	<input type="radio"/>	162.

Function Code	Name	Description	Setting Range	Factory Setting	Modify	No.
P8.18	Preset count value	P8.19-65535	P8.19-65535	0	<input type="radio"/>	163.
P8.19	Specified count value	0-P8.18	0-P8.18	0	<input type="radio"/>	164.
P8.20	Preset running time	0~65535h	0-65535	65535h	<input type="radio"/>	165.
P8.21	FDT level	0.00- P0.03	0.00-P0.03	50.00Hz	<input type="radio"/>	166.
P8.22	FDT lag	0.0-100.0%	0.0-100.0	5.0%	<input type="radio"/>	167.
P8.23	Frequency arrive detecting	0.0-100.0%(maximum frequency)	0.0-100.0	0.0%	<input type="radio"/>	168.
P8.24	Droop control	0.00-10.00 Hz	0.00-10.00	0.00Hz	<input type="radio"/>	169.
P8.25	Brake threshold voltage	115.0-140.0%	115.0-140.0	130.0%	<input type="radio"/>	170.
P8.26	Cooling fan control	0: Auto stop mode 1: Always working	115.0-140.0	120.0%	<input type="radio"/>	171.
P8.27	Overmodulation	0: Enabled 1: Disabled	0~1	0	<input type="radio"/>	172.
P8.28	PWM mode	0: PWM mode 1 1: PWM mode 2 2: PWM mode 3	0~1	0	<input type="radio"/>	173.

Function Code	Name	Description	Setting Range	Factory Setting	Modify	No.
P9 Group: PID Control						
P9.01	Keypad PID preset	0.0% ~100.0%	0.0-100.0	0.0%	<input type="radio"/>	175.
P9.02	PID feedback source selection	0: AI1 1: AI2 2: AI1+AI2 3: HDI 4: Communication	0-3	0	<input type="radio"/>	176.
P9.03	PID output characteristic	0: Positive 1: Negative	0~1	0	<input type="radio"/>	177.
P9.04	Proportional gain (Kp)	0.00-100.00	0.00-100.00	0.10s	<input type="radio"/>	178.
P9.05	Integral time (Ti)	0.01 ~10.00s	0.01-10.00	0.10s	<input type="radio"/>	179.
P9.06	Differential time (Td)	0.00-10.00s	0.00-10.00	0.00s	<input type="radio"/>	180.
P9.07	Sampling cycle (T)	0.01-100.00s	0.00-100.00	0.10s	<input type="radio"/>	181.
P9.08	Bias limit	0.0-100.0%	0.0-100.0	0.0%	<input type="radio"/>	182.
P9.09	Feedback Lost detecting value	0.0-100.0%	0.0-100.0%	0.0%	<input type="radio"/>	183.
P9.10	Feedback lost detecting time	0.0-3600.0s	0.0-3600.0	1.0s	<input type="radio"/>	184.

Function Code	Name	Description	Setting Range	Factory Setting	Modify	No.
PA Group: Simple PLC and Multi-step Speed Control						
PA.00	Simple PLC mode	0: Stop after one cycle 1: Hold last frequency after one cycle 2: Circular run	0-2	0	<input type="radio"/>	185.
PA.01	Simple PLC status saving after power off	0: Disabled 1: Enabled	0~1	0	<input type="radio"/>	186.
PA.02	Multi-step speed 0	-100.0 ~ 100.0%	-100.0- 100.0	0.0%	<input type="radio"/>	187.
PA.03	0 th Step running time	0.0-6553.5s(h)	0.0-6553.5	0.0s	<input type="radio"/>	188.
PA.04	Multi-step speed 1	-100.0-100.0%	-100.0- 100.0	0.0%	<input type="radio"/>	189.
PA.05	1 st Step running time	0.0-6553.5s(h)	0.0 ~6553.5	0.0s	<input type="radio"/>	190.
PA.06	Multi-step speed 2	-100.0-100.0%	-100.0- 100.0	0.0%	<input type="radio"/>	191.
PA.07	2 nd Step running time	0.0-6553.5s(h)	0.0 ~6553.5	0.0s	<input type="radio"/>	192.
PA.08	Multi-step speed 3	-100.0-100.0%	-100.0- 100.0	0.0%	<input type="radio"/>	193.
PA.09	3 rd Step running time	0.0-6553.5s(h)	0.0 ~6553.5	0.0s	<input type="radio"/>	194.
PA.10	Multi-step speed 4	-100.0-100.0%	-100.0- 100.0	0.0%	<input type="radio"/>	195.
PA.11	4 th Step running time	0.0-6553.5s(h)	0.0-6553.5	0.0s	<input type="radio"/>	196.
PA.12	Multi-step speed 5	-100.0 ~ 100.0%	-100.0- 100.0	0.0%	<input type="radio"/>	197.

Function Code	Name	Description	Setting Range	Factory Setting	Modify	No.
PA.11	4 th Step running time	0.0-6553.5s(h)	0.0-6553.5	0.0s	○	196.
PA.12	Multi-step speed 5	-100.0 ~ 100.0%	-100.0-100.0	0.0%	○	197.
PA.13	5 th Step running time	0.0-6553.5s(h)	0.0-6553.5	0.0s	○	198.
PA.14	Multi-step speed 6	-100.0 ~ 100.0%	-100.0-100.0	0.0%	○	199.
PA.15	6 th Step running time	0.0-6553.5s(h)	0.0-6553.5	0.0s	○	200.
PA.16	Multi-step speed 7	-100.0 ~ 100.0%	-100.0-100.0	0.0%	○	201.
PA.17	7 th Step running time	0.0-6553.5s(h)	0.0-6553.5	0.0s	○	202.
PA.18	Multi-step speed 8	-100.0 ~ 100.0%	-100.0-100.0	0.0%	○	203.
PA.19	8 th Step running time	0.0-6553.5s(h)	0.0-6553.5	0.0s	○	204.
PA.20	Multi-step speed 9	-100.0 ~ 100.0%	-100.0-100.0	0.0%	○	205.
PA.21	9 th Step running time	0.0-6553.5s(h)	0.0-6553.5	0.0s	○	206.
PA.22	Multi-step speed 10	-100.0 ~ 100.0%	-100.0-100.0	0.0%	○	207.
PA.23	10 th Step running time	0.0-6553.5s(h)	0.0-6553.5	0.0s	○	208.
PA.24	Multi-step speed 11	-100.0 ~ 100.0%	-100.0-100.0	0.0%	○	209.
PA.25	11 th Step running time	0.0-6553.5s(h)	0.0-6553.5	0.0s	○	210.

Function Code	Name	Description	Setting Range	Factory Setting	Modify	No.
PA.26	Multi-step speed 12	-100.0 ~ 100.0%	-100.0-100.0	0.0%	○	211.
PA.27	12th Step running time	0.0-6553.5s(h)	0.0-6553.5	0.0s	○	212.
PA.28	Multi-step speed 13	-100.0 ~ 100.0%	-100.0-100.0	0.0%	○	213.
PA.29	13th Step running time	0.0-6553.5s(h)	0.0-6553.5	0.0s	○	214.
PA.30	Multi-step speed 14	-100.0 ~ 100.0%	-100.0-100.0	0.0%	○	215.
PA.31	14th Step running time	0.0-6553.5s(h)	0.0-6553.5	0.0s	○	216.
PA.32	Multi-step speed 15	-100.0 ~ 100.0%	-100.0-100.0	0.0%	○	217.
PA.33	15th Step running time	0.0-6553.5s(h)	0.0-6553.5	0.0s	○	218.
PA.34	ACC/DEC time selection for step 0~7	0-0XFFFF	0-0XFFFF	0	○	219.
PA.35	ACC/DEC time selection for step 8~15	0-0XFFFF	0-0XFFFF	0	○	220.
PA.36	Simple PLC restart selection	0: Restart from step 0 1: Continue from paused step	0~1	0	◎	221.
PA.37	Time unit	0: Second 1: Minute	0~1	0	◎	222.

Function Code	Name	Description	Setting Range	Factory Setting	Modify	No.
PB Group: Protection Function						
Pb.00	Input phase-failure protection	0: Disable 1: Enable	0~1	1	<input type="radio"/>	223.
Pb.01	Output phase-failure protection	0: Disabled 1: Enabled	0~1	1	<input type="radio"/>	224.
Pb.02	Motor overload protection	0: Disabled 1: Normal motor(with low speed compensation) 2: Variable frequency motor (without low speed compensation)	0-2	2	<input checked="" type="radio"/>	225.
Pb.03	Motor overload protection current	20.0% ~120.0% (rated current of the motor)	20.0-120.0	100.0%	<input type="radio"/>	226.
Pb.04	Threshold of trip-free	70.0.0-110.0% (standard bus voltage)	70.0-110.0	80.0%	<input type="radio"/>	227.
Pb.05	Decrease rate of trip-free	0.00-P0.03 (the Max. frequency)	0.00-P0.03	0.00Hz/s	<input type="radio"/>	228.
Pb.06	Over-voltage Stall protection	0: Disabled 1: Enabled	0~1	1	<input type="radio"/>	229.
Pb.07	Over-voltage stall protection point	110~150%	110-150	130%	<input type="radio"/>	230.
Pb.08	Auto current limiting threshold	50-200%	50-200	G model : 150.0% P model: 160.0%	<input type="radio"/>	231.

Function Code	Name	Description	Setting Range	Factory Setting	Modify	No.
Pb.09	Frequency decrease rate when current limiting	0.00-100.00Hz/s	0.00-100.0 0	10.00Hz/s	○	232.
Pb.10	Auto current limiting selection	0: Enabled 1: Disabled when constant speed	0~1	0	○	233.
Pb.11	Selection of overtorque (OL3)	0 : No detection 1 : Valid detection of overtorque during running, then continue running 2 : Valid detection of overtorque during running, then waring and stop 3 : Valid detection of overtorque during constant speed running, then continue running 4 : Valid detection of overtorque during constant speed running, then waring and stop.	0-4	1	○	234.
Pb.12	Detection level of overtorque	10.0%~200.0%(relative to the rated current of the motor)	1.0-200.0	G model : 150.0% P model: 120.0%	○	235.
Pb.13	Detection time of overtorque	0.1 ~60.0s	0.0-60.0	0.1s	○	236.
Pb.14	Reserved				●	237.
Pb.15	Reserved				●	238.

Function Code	Name	Description	Setting Range	Factory Setting	Modify	No.
PC Group: Serial Communication						
PC.00	Local address	0~247 , 0 stands for the broadcast address	0-247	1	<input type="radio"/>	239.
PC.01	Baud rate selection	0: 1200BPS 1: 2400BPS 2: 4800BPS 3: 9600BPS 4: 19200BPS 5: 38400BPS	0-5	4	<input type="radio"/>	240.
PC.02	Data format	0: RTU, 1 start bit, 8 data bits, no parity check, 1 stop bit. 1: RTU, 1 start bit, 8 data bits, even parity check, 1 stop bit. 2: RTU, 1 start bit, 8 data bits, odd parity check, 1 stop bit. 3: RTU, 1 start bit, 8 data bits, no parity check, 2 stop bits. 4: RTU, 1 start bit, 8 data bits, even parity check, 2 stop bits. 5: RTU, 1 start bit, 8 data bits, odd parity check, 2 stop bits.	0-5	1	<input type="radio"/>	241.
PC.03	Communication delay time	0~200ms	0-200	5ms	<input type="radio"/>	242.
PC.04	Communication timeout delay	0.0: Disabled 0.1 ~100.0s	0.0-100.0	0.0s	<input type="radio"/>	243.
PC.05	Communication error action	0: Alarm and coast to stop 1: No alarm and continue to run 2: No alarm but stop according to P1.06 (if P0.03=2) 3: No alarm but stop according to P1.06	0-3	1	<input type="radio"/>	244.

Function Code	Name	Description	Setting Range	Factory Setting	Modify	No.
		2: RTU, 1 start bit, 8 data bits, odd parity check, 1 stop bit. 3: RTU, 1 start bit, 8 data bits, no parity check, 2 stop bits. 4: RTU, 1 start bit, 8 data bits, even parity check, 2 stop bits. 5: RTU, 1 start bit, 8 data bits, odd parity check, 2 stop bits.				
PC.03	Communication delay time	0~200ms	0-200	5ms	○	242.
PC.04	Communication timeout delay	0.0: Disabled 0.1 ~ 100.0s	0.0-100.0	0.0s	○	243.
PC.05	Communication error action	0: Alarm and coast to stop 1: No alarm and continue to run 2: No alarm but stop according to P1.06 (if P0.03=2) 3: No alarm but stop according to P1.06	0-3	1	○	244.
PC.06	Response action	Unit's place of LED 0: Response to writing 1: No response to writing Ten's place of LED 0: Reference not saved when power off 1: Reference saved when power off	00-11	00	○	245.
Pd Group: Supplementary Function						
PE Group: Factory Setting						